



Table Top Steam Sterilizer

Models T-Edge 10 and T-Edge 11

Cat. No. MAN205-0504001EN Rev. C



Tuttnauer. Ltd., Har Tuv Industrial Zone, B P.O. Box 170, Beit Shemesh, 9910101, Israel.

☎Tel: 972 2 9904611, 📠Fax: 972 2 9904730

🇺🇸Tuttnauer U.S.A. Co, Ltd., 25 Power Drive Hauppauge, NY, 11788, U.S.A.

☎Tel: (631) 737-4850, (800) 624-5836, 📠Fax: (631) 737-0720

Operation and Maintenance Manual

Table Top Steam Sterilizer

Models T-Edge 10 and T-Edge 11





<https://www.tuttnauerusa.com>

Table of Contents

| Paragraph | Page No. |
|---|----------|
| 1. GENERAL INFORMATION | 1 |
| 1.1 Manufacturer and US Official Correspondence Information | 1 |
| 1.2 Applicable Regulation and Quality Standards | 1 |
| 1.3 Legend for Symbols appearing on the Labels and in this Manual | 3 |
| 1.4 General Description of the Device | 5 |
| 1.5 Intended Use | 6 |
| 1.6 Intended Users | 6 |
| 1.7 Warranty Description | 6 |
| 1.8 Warranty Statement | 7 |
| 1.9 Customer Inspection Upon Receival of the Device | 7 |
| 1.10 Device Specifications | 8 |
| 1.11 Device Environmental Information | 12 |
| 1.12 Requirements with concern to Water Quality | 13 |
| 2. SAFETY | 14 |
| 2.1 Safety Notes | 15 |
| 2.2 Safety features incorporated in the device | 15 |
| 3. CONTENT OF THE DEVICE PACKAGE | 16 |
| 3.1 T-Edge 10 - 120V | 16 |
| 3.2 T-Edge 10 - 230V | 17 |
| 3.3 T-Edge 11 - 120V | 18 |
| 3.4 T-Edge 11 - 230V | 19 |
| 4. DEPICTION OF SYSTEM PARTS | 20 |
| 4.1 Front View | 20 |
| 4.2 Rear View | 21 |
| 5. INSTALLATION INSTRUCTIONS | 22 |
| 5.1 Lifting and Carrying | 22 |
| 5.2 Device Placement and Operating Conditions | 22 |
| 5.3 Connections to Utility Supplies | 23 |
| 5.4 Storage | 23 |
| 5.5 Initial Operation of the Device | 24 |

| | |
|---|----|
| 5.6 Before starting the Autoclave | 26 |
| 6. PRE-STERILIZATION CLEANING AND DISINFECTION OF INSTRUMENTS AND THEIR LOADING INTO THE DEVICE | 30 |
| 7. OPERATING INSTRUCTIONS | 33 |
| 7.1 Turning on the Device | 33 |
| 7.2 Filling Water | 33 |
| 7.3 Filling water in the reservoir | 35 |
| 7.4 See the requirements concerning Water Quality, in Section 1.12 | 36 |
| 7.5 Setting Date and Time | 37 |
| 7.6 Class S and Class B | 38 |
| 7.7 Setting Class S and Class B | 40 |
| 8. CONTROL PANEL | 42 |
| 8.1 Home screen Description and Functions | 43 |
| 8.2 Opening the Device Door | 45 |
| 8.3 Starting a Cycle | 46 |
| 8.4 Virus Protect program | 49 |
| 8.5 Available Sterilization Programs and Test Programs | 51 |
| 8.6 Cycle Succeeded / Cycle Failed Notifications and Follow-on | 54 |
| 8.7 Aborting a cycle | 55 |
| 8.8 Custom Programs | 56 |
| 8.9 Cycles history | 57 |
| 8.10 Opening the door and Unloading | 58 |
| 8.11 Checking Waste Water Level | 58 |
| 8.12 Draining the Reservoirs | 59 |
| 9. PREVENTIVE AND SCHEDULED MAINTENANCE TO BE PERFORMED BY THE OPERATOR | 61 |
| 9.1 Daily Maintenance | 61 |
| 9.2 Weekly Maintenance | 61 |
| 9.3 Monthly Maintenance | 62 |
| 9.4 Periodic Maintenance | 62 |
| 10. FULL LIST OF INFORMATIVE SCREEN DISPLAY SYMBOLS, OPERATING MESSAGES, ERROR MESSAGES AND TROUBLESHOOTING | 66 |
| 10.1 Symbols | 66 |
| 10.2 Error Messages & Troubleshooting | 67 |
| 11. TSC PRINTER INSTALLATION (OPTIONAL) | 74 |
| 11.1 General printer information | 74 |

| | |
|--|----|
| 11.2 Safety instructions | 76 |
| 11.3 Setting printer definitions | 77 |
| 12. SYSTEM CLEAN PROGRAM | 79 |
| 12.1 General | 79 |
| 12.2 System Clean Cleaning Procedure | 80 |

1. General Information

1.1 Manufacturer and US Official Correspondence Information



T-Edge 10 and T-Edge 11 Autoclaves are manufactured by Tuttnauer Ltd., Located Har – Tuv B Industrial Zone, P.O. Box 170, Beit Shemesh 9910101, Israel.

☎ Tel: +972-2-9904611

The US Official Correspondence is:

✉ Tuttnauer U.S.A. Co, Ltd. 25 Power Drive Hauppauge, NY, 11788, USA.

☎ Tel (631) 737 4850, (800) 624 5836, 📠 Fax: (631) 737 0720











1.2 Applicable Regulation and Quality Standards







The life cycle of Tuttnauer's T-Edge 10 and T-Edge 11 are in compliance with the following regulation and quality standards:

- **Medical Device Directive 93/42/EEC as amended by 2007/47/EC**
- **Medical Device Single Audit Program** - companion document, doc# MDSAP AU G0002.1.004 rev. 13-04-2017Ft
- **MDSAP audit approach** - doc# MDSAP AU P0002.005
- **FDA QSR 21 CFR part 820 & part 11**
- **Australian Therapeutic Goods** - (Medical Devices) Regulations 2002
- **Brazilian Good Manufacturing Practices** - (RDC ANVISA 16/2013, 67/2009, 56/2001, 23/2012)
- **Japanese QMS Ordinance** - (MHLW MO 169)
- **Canadian MDR (CMDR)** - SOR/98-282 (2018), consolidated
- **Global Unique Device Identification Database (GUDID)** - Guidance for Industry and Food and Drug Administration Staff
- **ISO 9001** - Quality Management System
- **EN ISO 13485** - Quality Management System – Medical Devices
- **ISO 14001** - Environmental management system
- **ISO 17025** - General requirements for the competence of testing and calibration laboratories
- **EN ISO 14971** - Medical devices – Application of risk management for medical devices
- **ASME Code** - Section I and Section VIII. Div. I
- **PED** - 2014/68/EU
- **Chinese Regulations** - Special Equipment Licensing Office
- **EN 13060** - Small Steam Sterilizer
- **ANSI/AAMI/ST55** - Tabletop Steam Sterilizer
- **ISO 17665** - Sterilization of health care products – Moist heat
- **ANSI/AAMI/ST79** - Comprehensive guide to steam sterilization and sterility assurance in health care facilities
- **IEC 61010-1 / UL 61010-1** - Safety requirements for electrical equipment for measurement, control, and laboratory use – Part 1: General requirements

- **IEC 61010-2-040** - Safety requirements for electrical equipment for measurement, control, and laboratory use – Part 2-040: Requirements for sterilizers and washer-disinfectors used to treat medical materials
- **EN 613261-1** - EMC Requirements for Electrical Equipment. The autoclave defines Class A - devices, are those that are marketed for use in a commercial, industrial, or business environment.
- **IEC 62304** - Medical Device Software – Software life cycle processes

1.3 Legend for Symbols appearing on the Labels and in this Manual

| | |
|---|---|
|  | Manufacturer |
|  | Year of Manufacturing |
|  | Medical Device |
|  | Model Number |
|  | Serial Number |
|  | Consult the Operation and Maintenance Manual (User Manual) before use |
|  | Keep away from sunlight and protect from heat. |
|  | For Indoor Use Only |
|  | Keep dry |
|  | Disposal according to electronic scrap ordinance |

| | |
|---|--|
|  | <p>This side up (during transport and shipment)</p> |
|  | <p>Fragile (during transport and shipment)</p> |
|  OR  | <p>A warning or precaution as detailed in the Operation and Maintenance Manual (User Manual)</p> |
|  OR  | <p>Caution! Hot Surface</p> |

1.4 General Description of the Device

The autoclave is fully automatic (a computerized control unit ensures a fully automatic sterilization cycle, control and monitoring of physical parameters and a clear documentation of the sterilization cycle. Drying is performed with the door closed).

This autoclave uses steam as a sterilizing agent.

The steam is produced by warming up a controlled amount of water inserted to a pipe heating element, and then to the chamber. This technique saves energy and water consumption.

The autoclave is equipped with a Pipe heating element and with chamber heaters to maintain the steam inside the chamber.

The autoclave is equipped with a vacuum system, which supports and improves:

- Removal of residual air from packs and porous load and most kinds of tubes (rubber, plastic etc.) by vacuum at the first stage of the cycle.
- Steam penetration into the load; resulting in effective sterilization.
- Temperature uniformity.
- Post sterilization drying phase

A touchscreen is used for monitoring and control purposes.

The device has 2 built -in USB ports to enable the operation of an external optional barcode printer:

- The barcode printer can print labels with a unique cycle ID barcode, operator name, sterilization and expiry dates
- One barcode printer can be connected to the machine.
- The printer connection to the machine, by using a USB socket, with a dedicated cable.
- Barcode printer power supply voltage can range between 100-240V.
- A barcode printer is an optional addition to the autoclave

The device features built-in memory to record up to 1000 sterilization cycles. These can be exported to a USB device to be transferred to a PC.

The device is Wi-Fi compatible, enabling remote tracking and monitoring by technicians and HQ services.

The device has a built-in Network Port for use with optional Tuttnauer's R.PC.R software when connected to your local network.

The autoclave has an automatic configuration where demineralized water has a direct inlet from the water supply system, demineralized water overflow, and waste water outlet on the rear cover.

1.5 Intended Use

The T-Edge 10 and T-Edge 11 tabletop autoclaves are designed for the sterilization of medical and surgical goods such as wrapped and unwrapped solid, hollow, and porous loads used in healthcare facilities (e.g. hospitals, nursing homes, extended care facilities, freestanding surgical centers, clinics and medical & dental clinics).

The T-Edge 10 and T-Edge 11 devices are validated for use in:

- Sterilizing fabric packs / textiles
- Sterilizing dental handpieces

1.6 Intended Users

The T-Edge 10 and T-Edge 11 tabletop autoclaves are intended for use by hospital personnel and other medical personnel .

All autoclave users must receive training in proper usage from an experienced employee. Every new employee must undergo a training period under an experienced employee.

1.7 Warranty Description

This warranty does not include routine cleaning and preventive maintenance, to be performed according to instructions in chapter 9.

This product is sold with a limited warranty and specific remedies are available to the original purchaser in the event that the product fails to conform to the limited warranty.

In general, and in a non-limited manner, Tuttnauer shall not be responsible for product damages caused by natural disasters, fire, static discharge, misuse, abuse, neglect, improper handling or installation, unauthorized repair, alteration or accident.

Tuttnauer's obligation is limited to the repair or replacement of parts for the device. This warranty will be void if the unit is not purchased from an authorized Tuttnauer dealer. No other warranties or obligations are expressed or implied.

1.8 Warranty Statement

The warranty registration must be completed and returned to our service departments; within fourteen (14) days of purchase or the warranty will be void.

Our American Representative's Technical Service Department can be reached at:

✉ Tuttnauer U.S.A. Co, Ltd. 25 Power Drive Hauppauge, NY, 11788, USA.

☎ Tel: (631) 737 4850, (800) 624 5836, 📠 Fax: (631) 737 0720

Note: If there is any difficulty with this autoclave, and the solution is not covered in this manual, contact our representative or us first. Do not attempt to service this autoclave yourself. Describe the difficulty as clearly as possible so we may be able to diagnose the problem and provide a prompt solution.

If replacement parts are needed, stipulate the model and serial number of the machine.

No autoclaves will be accepted for repair without proper authorization from us. All transportation charges must be paid both ways by the owner.

For technical information or service please contact us at:

✉ Tuttnauer U.S.A. Co, Ltd. 25 Power Drive Hauppauge, NY, 11788, USA.

☎ Tel: (631) 737 4850, (800) 624 5836, 📠 Fax: (631) 737 0720

✉ Tuttnauer Ltd., Har – Tuv B Industrial Zone, P.O. Box 170, Beit Shemesh 9910101, Israel

☎ Tel: +972-2-9904611

1.9 Customer Inspection Upon Receipt of the Device

Upon receiving your Tuttnauer Autoclave, carefully inspect the outside of the shipping carton for signs of damage. If any damage to the carton is found, note the location with respect to the autoclave and check that area of the autoclave carefully once it is fully unpacked. Observe packing method and retain packing materials until the unit has been inspected. Mechanical inspection involves checking for signs of physical damage such as: scratched panel surfaces, broken knobs, damaged gasket etc.

If any damage is found, contact your dealer as soon as possible so that they can file a claim with the shipping carrier and also notify Tuttnauer.

All Tuttnauer products are carefully inspected prior to shipment and all reasonable precautions are taken in preparing them for shipment to assure safe arrival at their destination.

Manufacturer Sterilization Performance Validation

The sterilization performance validation of all sterilization programs and test programs were performed by the manufacturer according to EN 13060.

1.10 Device Specifications

1.10.1 Overall Dimensions - T-Edge 10:

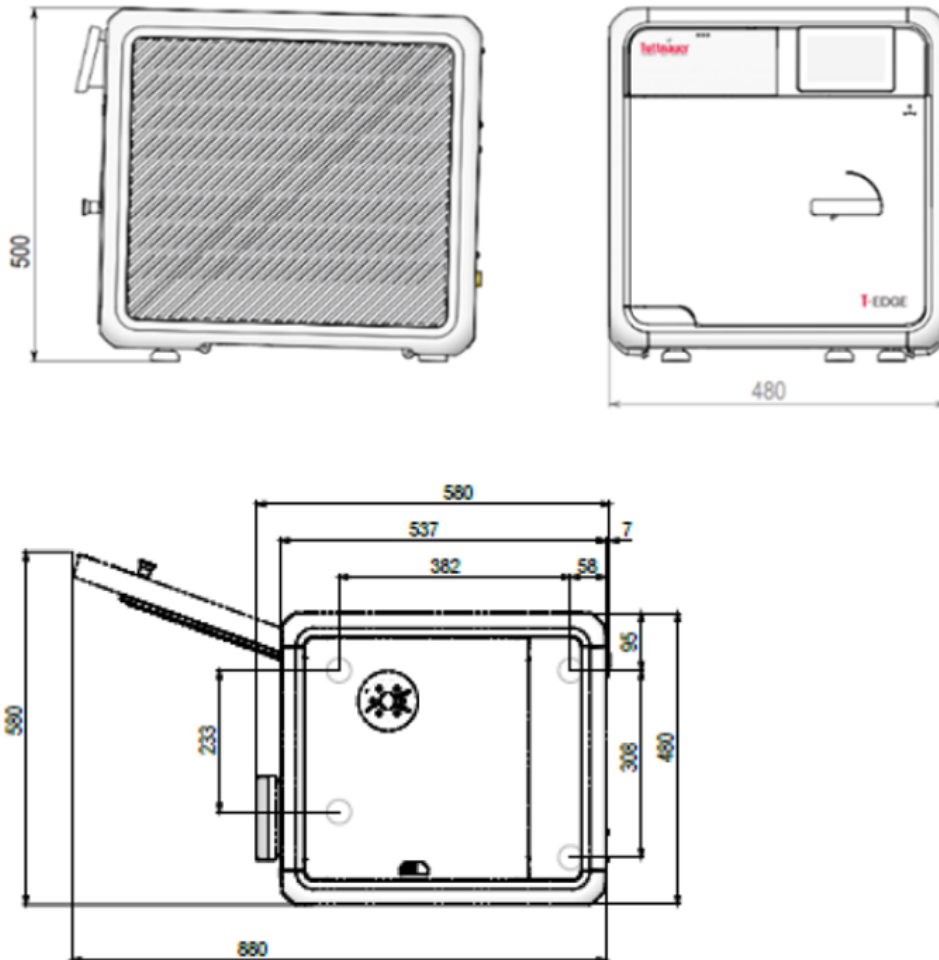

1.10.2 Overall Dimensions - T-Edge 11

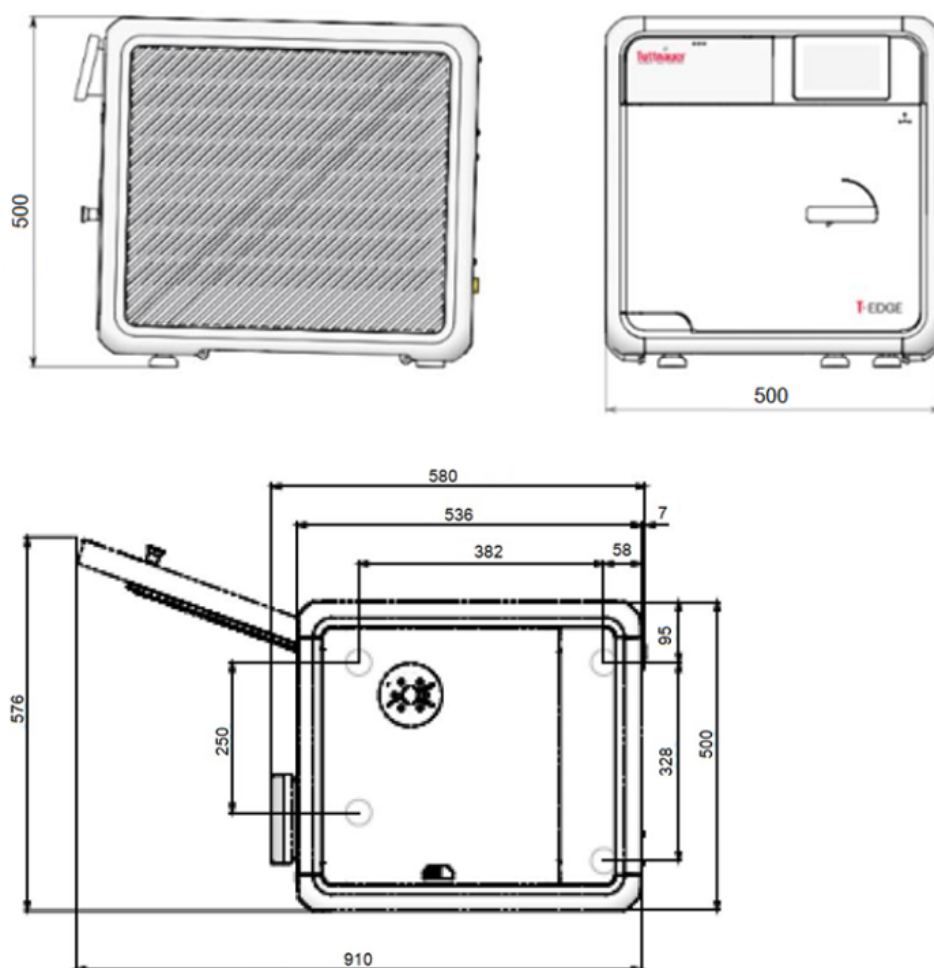

1.10.3 T-Edge fit into sterilization center cabinet - recommended dimensions:

To allow adequate cooling & ventilation of the autoclave placed inside the sterilization center Cabinet, the following T-Edge cabinet sizes are recommended:

T-Edge 10:

Width - 22.85" - 23.65"/58-60cm; Height – 22.25" - 22.65"/56.5-57.5cm; Min. Depth - 24.9"-25.2"/63.2-64cm

T-Edge 11:

Width - 23.65" - 24.40"/60-62cm; Height – 22.25" - 22.65"/56.5-57.5cm; Min. Depth - 24.9"-25.2"/63.2-64cm

Note: The imperial dimensions in inches/lbs are approximated to less than 3 percent.

1.10.4 Device Properties

| Property | | Dimension | |
|--|----------------------|---|--|
| | | T-Edge 10 | T-Edge 11 |
| External size | Width | ~19"(48cm) | ~19.7"(50cm) |
| | Height | ~19.7"(50cm) | |
| | Depth | ~22.8" (58 cm) supporting common install base carry a ~23" (60 cm) counter top | |
| Chamber | Diameter | ~10"(25 cm) | ~11"(28 cm) |
| | Depth | ~18"(46 cm) | |
| | Volume | ~778 Ounces (23lit) | ~913 Ounces (27.2lit) |
| | Usable chamber space | 75% (~575 Ounces / ~17 L) | 75% (~685 Ounces / ~20.5 L) |
| Max. Allowable Working Pressure (MAWP) | | ~40.6PSI (2.8 bar) | |
| Maximum load per item | | ~0.45 lbs. (0.2kg) | |
| Maximum load per tray | Unwrapped | ~2.67 lbs (1.2kg) | ~4 lbs (1.8kg) |
| | Wrapped | ~1.6 lbs (0.72kg) | ~2.4 lbs (1.08kg) |
| Maximum Solid load | Unwrapped | ~13 lbs (6kg) | ~19.8 lbs (9kg) |
| | Wrapped | ~7.7 lbs (3.5kg) | ~11.9 lbs (5.4kg) |
| Maximum textile load | | ~3.3 lbs (1.5kg) | ~4.4 lbs (2kg) |
| Tray dimensions | | ~16.6" x~7.4"x~0.8" (42.1cm x 18.9cm x 2.05cm) | ~16.6" x~8.14"x~0.8" (42.1cm x 20.7cm x 2.05cm) |
| No. of trays | | 5 | |
| Net weight | | ~111lbs (50.5kg) | ~128lbs (58kg) |
| Shipping weight | | ~138lbs (62.5kg) | ~154lbs (70kg) |
| Floor loading requirements | | ~168 lbs (76kg) | ~192 lbs (87kg). |
| Mineral-free water reservoir | Max. water volume | Overflow (up to the float) ~128 Ounces (3.8lit) | Overflow (up to the float) ~155 Ounces (4.6lit) |

| Property | | Dimension | |
|------------------------------|--|---|--|
| | | T-Edge 10 | T-Edge 11 |
| | Min. water volume | ~33.8 Ounces (1lit) | |
| | The volume used by the sterilization cycle/load having the highest steam consumption | Recorded 27 Ounces (800ml) were required to sterilize full load of porous type using "wrapped 121". | ~30 Ounces (~900ml) for Wrapped 273F + virus protect |
| Used (waste) water reservoir | Max. water volume | Max vol. –./~135 Ounces /(4.0 lit) Float – ~125 Ounces (3.7lit.) max allowed for start cycle | |
| Safety relief valve | | ~40 PSI (2.8 bar) | |
| Load No. counter | | Counting from 0 to 999 and nullifies. | |

1.10.5 Device Electrical Data

| Property | Value | |
|-------------------------------------|---------------|---------------|
| | 230V | 120V |
| Total Power | 1960W | 1500W |
| Voltage | 1Ph / 230 VAC | 1Ph / 120 VAC |
| Amperage | 9A | 12.5A |
| Protection against electrical shock | IEC 61010-1 | |
| Mains supply fluctuation | +/- 10% | |
| Frequency (Hz) | 50/60Hz | 60Hz |

1.10.6 Utility Requirements

| Property | Value | |
|-----------------------------|---|---------------------------------|
| | 230V | 120V |
| Mineral-free water | See table in Water Quality | |
| Mineral-free water inlet | Optional - 1/2" automatic | |
| Drain | Optional - 3/4", withstanding temp. of 80°C | |
| Power supply | * 1 phase, 230VAC ±10%, 50/60Hz | * 1 phase, 120VAC ±10%, 60Hz |
| Recommended circuit breaker | 16A | 15A |

* According to the local network.



Caution!

In order to avoid any injury by electrical hazard, it is recommended that a ground fault protection device (GFCI) be installed in the electrical panel feeding the autoclave (local codes may make this mandatory).

The electrical network must comply with local rules and regulations.

Verify that there is an easy access to the main power switch and to the current leakage safety relay (GFCI). The voltage supplied to the device must comply with the label ± 10%.

1.11 Device Environmental Information

- The peak sound level generated by the autoclave is 67dBa with background noise of 48dBa during sterilization stage, and 65dBa during drying stage.
- The total heat per hour transmitted by the autoclave is <200Wh.

1.12 Requirements with concern to Water Quality

The distilled or mineral-free water supply to the autoclave shall be according to the table below:

Suggested Maximum Limits of Contaminants in Water for Steam Sterilization per EN13060

| Substance | Feed Water | Condensate |
|---|-------------------------------------|---------------|
| Evaporate residue | ≤ 10 mg/l | ≤ 1.0 mg/l |
| SiO ₂ | ≤ 1 mg/l | ≤ 0.1 mg/l |
| Iron | ≤ 0.2mg/l | ≤ 0.1mg/l |
| Cadmium | ≤ 0.005 mg/l | ≤ 0.005 mg/l |
| Lead | ≤ 0.05 mg/l | ≤ 0.05 mg/l |
| Rest of heavy metals except iron, cadmium, lead | ≤ 0.1 mg/l | ≤ 0.1 mg/l |
| Chloride (Cl) | ≤ 2 mg/l | ≤ 0.1 mg/l |
| Phosphate | ≤ 0.5 mg/l | ≤ 0.1 mg/l |
| Conductivity (at 20°C) | ≤15 µs/cm | ≤ 3 µs/cm |
| pH value | 5 to 7.5 | 5 to 7 |
| Hardness | ≤ 0.02 mmol/l | ≤ 0.02 mmol/l |
| Appearance | Colorless, clean, without sediments | |

Compliance with the above data should be tested in accordance with acknowledged analytical methods, by an authorized laboratory.



Caution!

The use of water for autoclaves that do not comply with the table above may have severe impact on the working life of the sterilizer and can invalidate the manufacturer's guarantee.

Use only deionized water, having a maximum conductivity of 15 µs/cm. Conductivity greater than 15 µs/cm may cause failures.











1.12.1 Tap water supply

The range of hardness value 0.7-2.0 mmol/l (70- 200 mg/l CaCO₃)

The use of soft water is strictly forbidden! Please consult a water specialist!

Note: We recommend testing the water quality once a month. The use of water for autoclaves that does not comply with the table above may have severe impact on the working life of the sterilizer and can invalidate the manufacturer's guarantee.

2. Safety

| | |
|---|--|
|  Caution! | <p>Always operate the autoclaves strictly as instructed in this user manual.</p> |
|  Attention! | <p>The device is designed to carry safeguards against cybersecurity threats. If you fear the device has been compromised, immediately contact the authorized representative.</p> |
|  Caution! | <p>Instruments should not be loaded into the autoclave to be sterilized unless Steam Sterilization is instructed in their User Manual. The instructed Steam Sterilization Program should be verified against the programs available in this autoclave.</p> |
|  Caution! | <p>Never use the autoclave to sterilize corrosive products (acids, bases, or phenols) volatile compounds or solutions (ethanol, methanol or chloroform), or radioactive substances.</p> |
|  Warning! | <p>Always wear heat resistant gloves before unloading and avoid touching hot load and hot surfaces.</p> |
|  Warning! | <p>Don't place your hand or head, etc. above the door while opening it as hot steam is escaping the chamber.</p> |
|  Warning! | <p>Do not stand near the back panel of the autoclave while the device is operating as the pressure safety valve may release steam.</p> |
|  Warning! | <p>Do not touch hot surfaces, such as the top enclosure and area adjacent to the chamber opening! Hot surfaces are indicated with a label (see sec. 1.3 above)</p> |
|  Caution! | <p>Only technical personnel having proper qualifications and holding technical documentation (including a technician manual) and adequate information are authorized to install and serve the apparatus</p> |
|  Caution! | <p>In order to assure proper operation of the autoclave, it should not be placed in the vicinity of electrical equipment which is not certified for Electromagnetic Compatibility according to IEC/EN 61326-1.</p> |

2.1 Safety Notes

- All new autoclave users must undergo a period of training in proper usage under an experienced employee.
- Before initial use, check the autoclave chamber to ensure that no packaging materials have been left inside.
- Before use, check inside the autoclave chamber to ensure that no items have been left from the previous cycle.
- Always verify that you have chosen the appropriate sterilization program
- After the cycle, open the door slowly to allow steam to escape and wait 20 seconds before you remove the load.
- A certified inspector must perform a periodic pressure chamber safety test according to the local regulations.
- Once a year, or more frequently, effectiveness tests must be performed, i.e., calibration and validation.
- Make sure there are no leaks, breaks, blockages, whistles or strange noises.
- Perform maintenance operations as instructed. The owner of the autoclave is responsible to perform the maintenance operations.
- Notify the person in charge immediately of any deviation from the normal functioning of the device.
- Protective equipment and clothes and other safety instructions shall be implemented in accordance with local and national regulations and/or rules.

2.2 Safety features incorporated in the device

The pressure vessel chamber door has the following features protecting personnel from hazards:

- Two door switches indicate that the door is closed. Without this indication steam is not introduced into the chamber.
- An electrical door locking pin that blocks door opening during operation.

The following safety devices are installed in the autoclave to optimize its safe operation:

- Safety thermostat, to prevent over-heating of the chamber heating elements.
- Safety cut-off switch to prevent over-heating of the pipe heating element.
- Safety pressure valve to prevent over-pressurizing of the chamber.



Warning! Mind the power socket. Keep it and its vicinity dry. Danger of electrocution.

3. Content of the Device Package

3.1 T-Edge 10 - 120V

| Part Number | Part Description | Quantity Supplied |
|------------------|---|-------------------|
| AMS10-120-W-T | T-Edge 10 Autoclave | 1 |
| TRY511-0003 | Aluminum Tray for 10" | 5 |
| TRH511-0003 | Wire Tray holder for 5 trays or USA Cassettes-10 | 1 |
| CLE096-0076 | T-System Clean 6 Tablets | 1 |
| CMT240-0002 | Tray Handle | 1 |
| PIP411-0042 | Tube for Reservoir Drain | 1 |
| WIR040-0232 | Cable, Plug + Socket 110V 15A, USA | 1 |
| 03-134-05 | Autoclave Calibration Report | 1 |
| MAN205-0504001EN | Operation and Maintenance Manual (USA) | 1 |
| MAN205-1500000EN | Table-Top and Vertical autoclave log book | 1 |
| MAN205-0030EN | Certificate, Warranty, 2 Year - USA | 1 |
| LTR231-0054 | Brochure-Tuttnauer USA product insert | 1 |
| LTR231-0055 | Brochure-Our number one priority is your safety and health) | 1 |

3.2 T-Edge 10 - 230V

| Part Number | Part Description | Quantity Supplied |
|------------------|---|-------------------|
| AMS10-230-W-T | T-Edge 10 Autoclave | 1 |
| TRY511-0003 | Aluminum Tray for 10" | 5 |
| TRH511-0003 | Wire Tray holder for 5 trays or Cassettes, USA | 1 |
| CLE096-0076 | T-System Clean 6 Tablets | 1 |
| CMT240-0002 | Tray Handle | 1 |
| PIP411-0042 | Tube for Reservoir Drain | 1 |
| WIR040-0005 | Cable, Plug + Socket 250V 15A, USA | 1 |
| 03-134-05 | Autoclave Calibration Report | 1 |
| MAN205-0504001EN | Operation and Maintenance Manual (USA) | 1 |
| MAN205-1500000EN | Table-Top and Vertical autoclave log book | 1 |
| MAN205-0030EN | Certificate, Warranty, 2 Year - USA | 1 |
| LTR231-0054 | Brochure-Tuttnauer USA product insert | 1 |
| LTR231-0055 | Brochure-Our number one priority is your safety and health) | 1 |

3.3 T-Edge 11 - 120V

| Part Number | Part Description | Quantity Supplied |
|------------------|---|-------------------|
| AMS11-120-W-T | T-Edge 11 Autoclave | 1 |
| TRY510-0001 | Aluminum Tray for 11" | 5 |
| TRH510-0001 | Wire Tray Holder T-EDGE-11" For 5 Trays or Cassettes, USA | 1 |
| CLE096-0076 | T-System Clean 6 Tablets | 1 |
| CMT240-0002 | Tray Handle | 1 |
| PIP411-0042 | Tube for Reservoir Drain | 1 |
| WIR040-0232 | Cable, Plug + Socket 110V 15A, USA | 1 |
| 03-134-05 | Autoclave Calibration Report | 1 |
| MAN205-0504001EN | Operation and Maintenance Manual (USA) | 1 |
| MAN205-1500000EN | Table-Top and Vertical autoclave log book | 1 |
| MAN205-0030EN | Certificate, Warranty, 2 Year - USA | 1 |
| LTR231-0054 | Brochure-Tuttnauer USA product insert | 1 |
| LTR231-0055 | Brochure-Our number one priority is your safety and health) | 1 |

3.4 T-Edge 11 - 230V

| Part Number | Part Description | Quantity Supplied |
|------------------|---|-------------------|
| AMS11-230-W-T | T-Edge 11 Autoclave | 1 |
| TRY510-0001 | Aluminum Tray for 11" | 5 |
| TRH510-0001 | Wire Tray holder for 5 trays or Cassettes, USA | 1 |
| CLE096-0076 | T-System Clean 6 Tablets | 1 |
| CMT240-0002 | Tray Handle | 1 |
| PIP411-0042 | Tube for Reservoir Drain | 1 |
| WIR040-0005 | Power Cable 15A 250VAC (USA) | 1 |
| 03-134-05 | Autoclave Calibration Report | 1 |
| MAN205-0504001EN | Operation and Maintenance Manual (USA) | 1 |
| MAN205-1500000EN | Table-Top and Vertical autoclave log book | 1 |
| MAN205-0030EN | Certificate, Warranty, 2 Year - USA | 1 |
| LTR231-0054 | Brochure-Tuttnauer USA product insert | 1 |
| LTR231-0055 | Brochure-Our number one priority is your safety and health) | 1 |

4. Depiction of System Parts

4.1 Front View

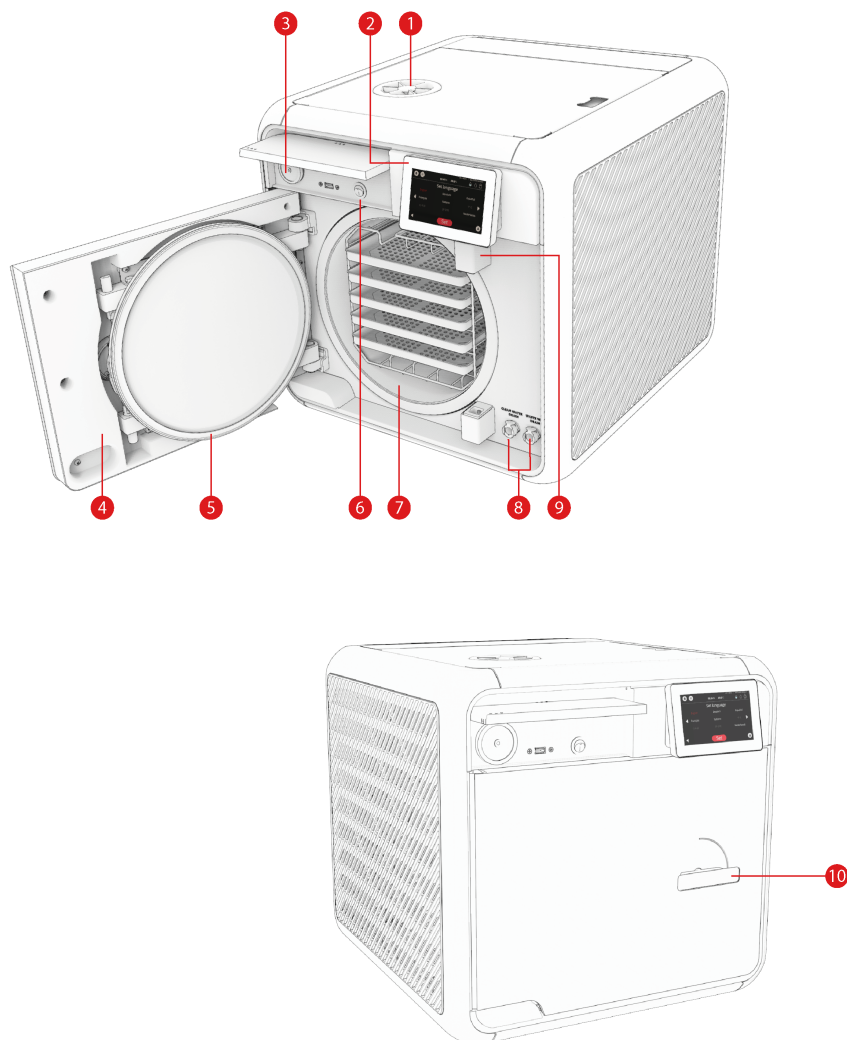

| No. | Description | No. | Description |
|-----|--------------------------------------|-----|--|
| 1 | Mineral-free water reservoir opening | 6 | ON/OFF switch |
| 2 | Touch screen | 7 | Chamber |
| 3 | Air filter | 8 | Mineral-free (left) and waste water (right) reservoir drains |
| 4 | Chamber Door | 9 | Door switches |
| 5 | Door Gasket | 10 | Door Handle |

4.2 Rear View

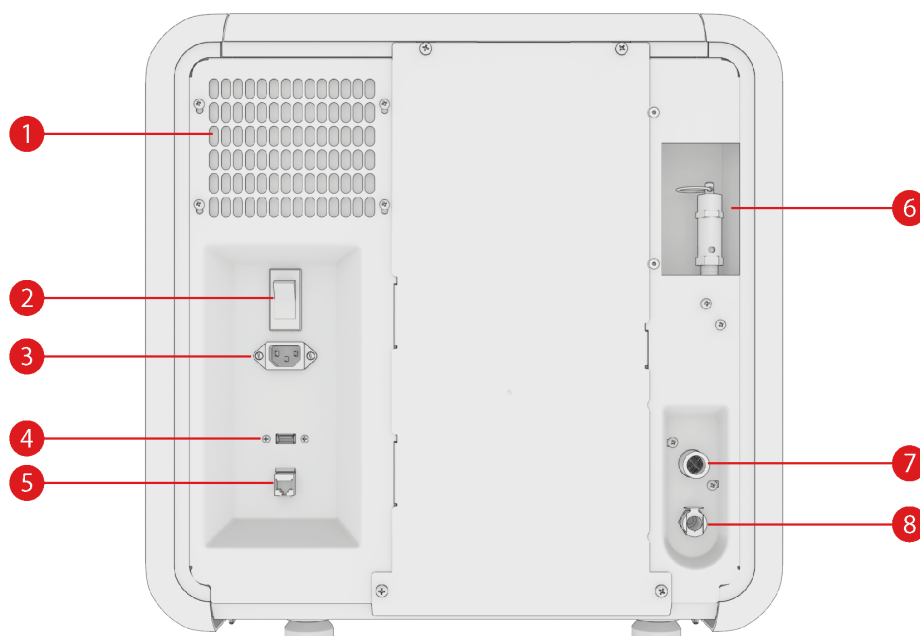

| No. | Description | No. | Description |
|-----|------------------------------|-----|--------------------|
| 1 | Aeration ventilation opening | 5 | LAN socket |
| 2 | ON/OFF switch | 6 | Safety valve |
| 3 | Power socket | 7 | Mineral-free inlet |
| 4 | USB port | 8 | Waste outlet |



Warning! Mind the power socket. Keep it and its vicinity dry. Danger of electrocution.

5. Installation Instructions

5.1 Lifting and Carrying



Cautions!

Before moving the autoclave, make sure that the electric cord is disconnected from the power, and there is no pressure in the chamber.

Drain the water from the reservoir (see 8.12 Draining the Reservoirs)

Do not drop the device!

To avoid injuries, lifting and carrying should be done with at least two people or by using a fork-lift or any other mechanical aid.

5.2 Device Placement and Operating Conditions

1. The autoclave is intended for indoor use only.
2. Check and verify that the counter carrying the autoclave is a rigid and leveled surface and can carry a load of 168 lbs (T-Edge 10) / 192 lbs (T-Edge 11) .



Caution! The device is not designed for use on any standard slide out shelf. If it is necessary to use a slide out shelf, it must be tested and/or rated for 168 lbs (T-Edge 10) / 192 lbs (T-Edge 11) or more.

3. Check and verify that the dimensions of the surface of the counter are at least 21"(55cm) x 23" (60cm).
4. Keep the back and the sides of the autoclave approximately 10cm away from the wall to allow ventilation and facilitate the device disconnection.
5. If placed in a cabinet, verify that the rear of the cabinet is open to allow ventilation.
6. It is recommended that enough space be left around the autoclave to give a technician access for servicing the machine.
7. Check and verify that the ambient temperature range is 41°F (5°C)-104°F(40°C).
8. Check and verify that the ambient relative humidity does not exceed 80%.
9. The operational altitude shall not be over 13123 ft (4000 meters).
10. Ambient pressure shall not be lower than 8.8 psi (60.5 KPa).
11. Operate the autoclave only in the manner specified in the manual. If the equipment is used in a manner not specified by the manufacturer, the protection provided by the equipment may be impaired.

5.3 Connections to Utility Supplies

1. Check and verify that the power supply is as follows:
230V - 1 phase, 230VAC $\pm 10\%$, 50/60Hz.
120V - 1 phase, 120VAC $\pm 10\%$, 60Hz.
2. Check and verify that the electrical net is protected by a current leakage safety relay.
3. The autoclave defines Class A - devices are those that are marketed for use in a commercial, industrial, or business environment.

5.4 Storage

After the removal of the autoclave from the package, we recommend the following:

Keep the device dry.

Keep the device away from sunlight and protect it from heat.

5.5 Initial Operation of the Device

Note: Remove all packaging material before turning ON the device.

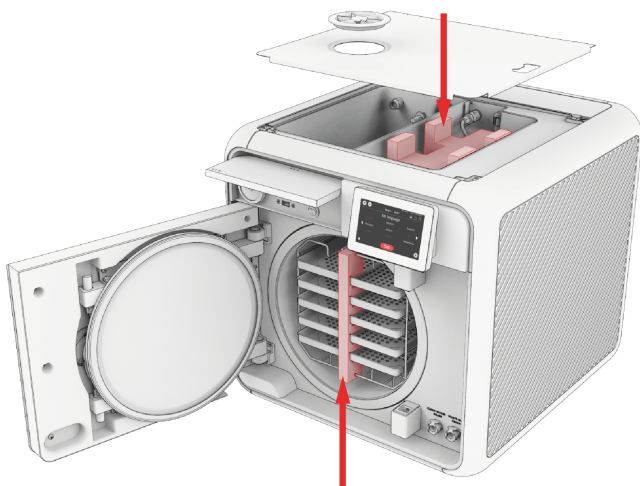

1. Plug the power cord into the power socket.

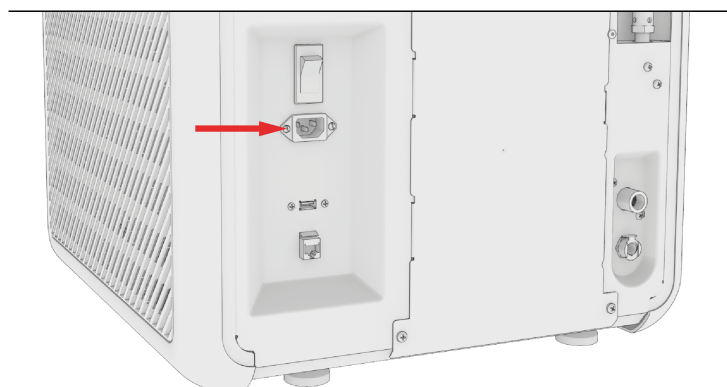

Warning! Mind the power socket. Keep it and its vicinity dry. Danger of electrocution.

2. Turn ON the semi-automatic ON/ OFF button switch located on the bottom left side of the back panel of the autoclave.

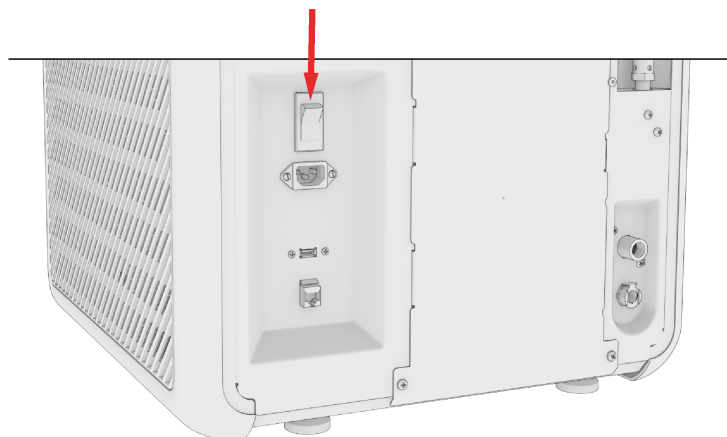

3. Turn on the ON/ OFF Switch mounted on the bottom left side of the front panel.

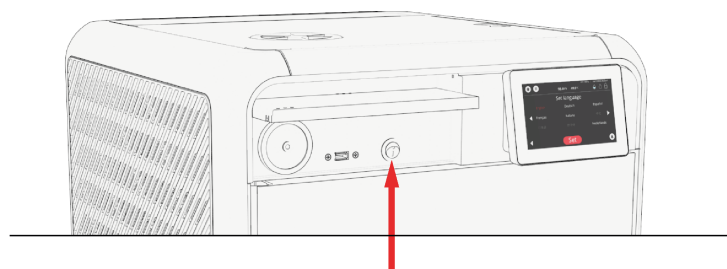

4. When you turn on the autoclave, it will automatically warm up.



Warning! Be careful the surfaces may be hot!

5. Fill the Mineral Free Water Reservoir with water meeting the quality specs (see Water Quality and Filling the Mineral-Free Water Reservoir).
6. Set date and time (see Set date and time).

5.6 Before starting the Autoclave

Note: The device automatically resets the Atmospheric Pressure when turned on.

Open the Autoclave door for 2 minutes and verify that the ambient temperature is below 113°F.

To reset the Atmospheric Pressure manually:

1. In the **Quick Option** screen, press the **Settings** icon , then browse to Maintenance/Reset atmospheric pressure.

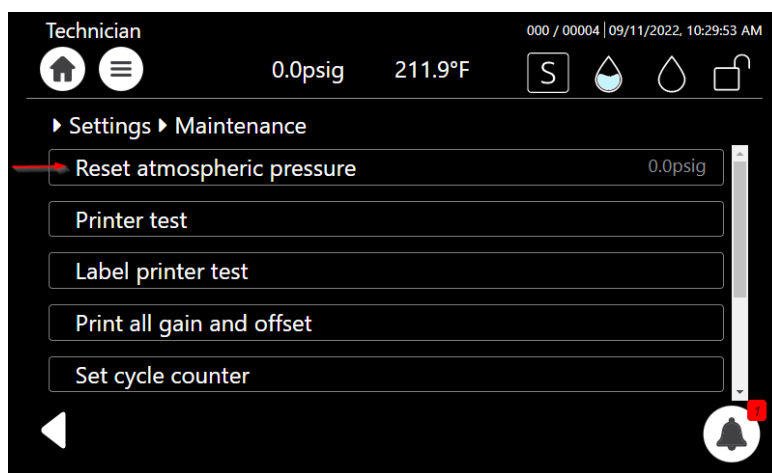

2. In the confirmation screen, press **Reset**.

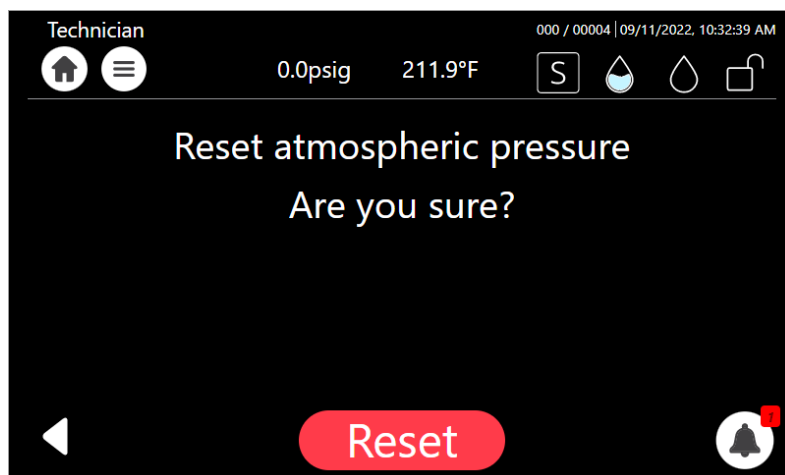

Wi-Fi Configuration

Prior to operating the autoclave for the first time, please connect the Wi-Fi and ensure it remains connected at all times.

The Wi-Fi connection is used for uploading all data information from devices in the field, to the online company's server.



This data is used for:

- Monitoring
- Viewing and downloading device history
- Software updates while validating the integrity of the update (applicable for users with Tuttnauer code)

The data is backed-up on the device main board.

Note: In case of connection failure, the data may be exported manually.

To connect the Wi-Fi:

1. In the **Quick Option** screen, press the **Wifi Configuration** option .
2. To enable the connection, press **On** .
3. The **Wifi Configuration** screen is displayed with the available networks.

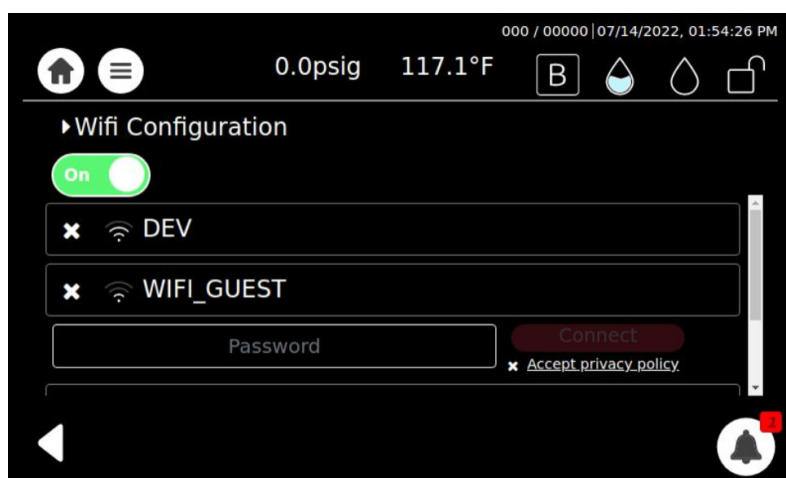

4. Select your network, enter your **Password** and press the **Accept privacy policy**.

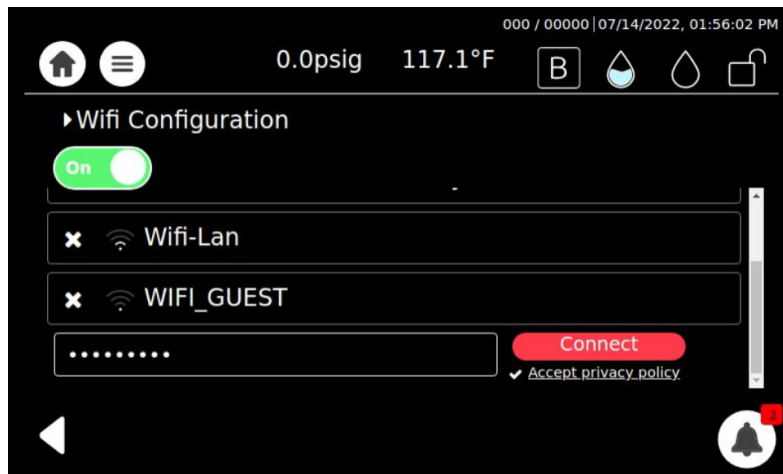

5. Press **Connect**.
6. The Wi-Fi is connected successfully. Press **Ok**.

Checking the device Version information.

1. In the **Quick Option** screen, press the **Info** option .
2. Select the **Version information**.



3. The Version information is displayed. For an example, see below:

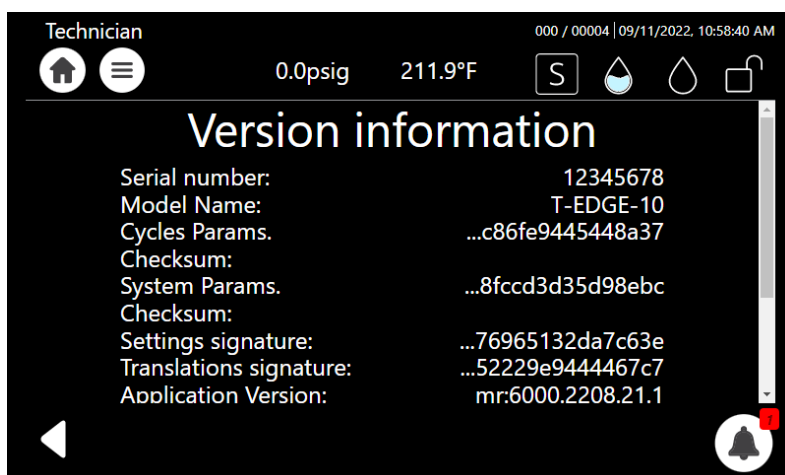

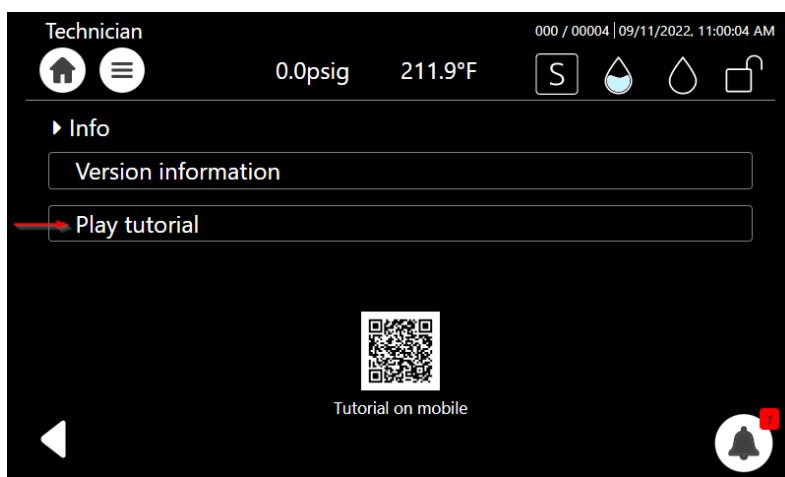

4. Press on the  to return to the **Info** screen.
5. Select the **Play tutorial** option to watch the T-Edge Instructional Video



6. The T-Edge Instructional Video can be accessed in the link below:

<https://tuttnauer.com/t-edge10/en/video/how-to>

6. Pre-sterilization Cleaning and Disinfection of Instruments and their Loading into the Device

| | |
|---|--|
|  Caution! | Instruments should not be loaded into the autoclave to be sterilized unless Steam Sterilization is instructed in their User Manual. The instructed Steam Sterilization Program should be verified against the programs available in this autoclave. |
|  Caution! | Never use the autoclave to sterilize corrosive products (acids, bases, or phenols) volatile compounds or solutions (ethanol, methanol or chloroform), or radioactive substances. |

The most important stage begins with removing debris by cleaning and rinsing. Effective cleaning is affected by several factors: water quality, type, concentration and quality of a cleaner, effective washing method, and adequate rinsing and drying.

Cleaning dried blood is especially difficult because it flows and dries in difficult-to-clean locations. It shall be washed away. Mechanically scrubbing, high pH detergents, enzymatic solutions, and water spray at high pressure will clean this contamination.

Note: Consult the Medical Device manufacturer relating adequate and most effective cleaning method and cleaning agents.

Instruments which are composed of several components shall be dismantled.

Disinfection is the next step. It is important for safe handling. There are various methods and means for disinfection like soaking in liquid chemical disinfectants or hot water disinfection.

Packaging. The target in packing medical items is to assure that the contained goods are sterile and maintaining them sterile till opening the package.

There are various methods and techniques used in preparation and packaging of surgical instruments.

Check the instructions of the item manufacturer as to the proper procedure for cleaning and sterilizing each item. The item manufacturer's instructions always supersede any other instructions.

- Clean instruments immediately after use to remove any residue. It is recommended that all instruments be ultrasonically cleaned using Tuttnauer's Clean & Simple enzymatic cleaning tablets or other suitable solution.
- After cleaning, rinse instruments under tap water for 30 seconds and pat or air dry to remove residual minerals. If your tap water has a high mineral content, then rinse a second time in a bath of distilled water to remove minerals and pat dry.
- Launder textile wraps prior to sterilization, thoroughly rinse wraps laundered in chlorine bleach. Chlorine bleach can harm your stainless-steel instrument and the sterilizer.
- Follow the instrument manufacturer's instructions on the use of products for cleaning and lubricating instrument that have been ultrasonically cleaned.
- Be sure that instruments of dissimilar metal (stainless steel, carbon steel, etc.) are separated. Carbon steel instruments should be bagged or placed on autoclavable towels and not directly on stainless

steel trays (mixing will result in damage to the instruments or trays from the oxidation of these materials).

- Load items within the boundaries of the tray so that they do not touch the chamber walls or fall off when the tray is moved. Items should not be allowed to touch the walls of the Chamber as the hot metal can damage the item.
- Don't overload the Sterilizer trays (see Specification). Overloading will cause inadequate sterilization & drying.
- Make sure that all instruments remain apart during the sterilization cycle. Surfaces that are hidden because items are covering other items will not be exposed to the steam and will not be sterilized.
- Disassemble or sufficiently loosen multiple-part instruments prior to packaging to permit the sterilizing agent to come into direct contact with all parts of the instrument.
- Verify that packaging methods are in accordance with the good practice approach and the packaging materials used are in agreement with applicable standards.
- Tilt on edge items prone to entrap air and moisture, e.g. hollowware, so that only minimal resistance to air removal exist, the passage of steam and condensate will be met.
- Wrapped instruments should be placed in material which will allow steam penetration and promote drying, such as autoclave bag, autoclave paper, or muslin towels.
- When loading pouches on the tray, put them with paper side up, nylon side towards the tray (see the figures below)



- Tubing should be rinsed after cleaning. When placed in the tray, make sure that both ends of the tubing are open and there are no sharp bends or twists.

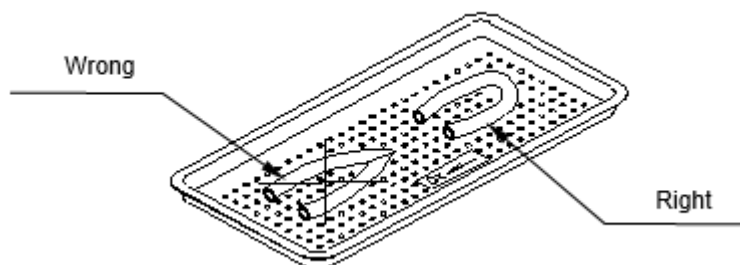

- Cassettes should be placed on the tray rack in place of the trays. They should not be touching each other or the Chamber walls. There should be about 1" (2.5cm) between cassettes or packs for proper steam circulation.

- If spotting is detected on the instruments it is necessary to determine if the spot is dirt or rust. The first step would be to use an ordinary eraser to remove the spot. If there is no pitting under the spot, then the spot is only dirt. Dirt spots on an instrument may be an indication that the autoclave needs to be cleaned or that the instruments were not adequately cleaned or dried prior to sterilization. If removal of the spot reveals pitting, then the spot is most likely rust. Rust spots on an instrument are not uncommon on inexpensive instruments. It may also be an indication that the instruments were rinsed in tap water with a high mineral content. These minerals when exposed to high temperature and steam will accelerate the oxidation of the metal. One suggestion would be to final rinse the instruments in a distilled water bath and pat dry to absorb residual water and minerals.
- If the instruments exhibit a discoloration this can be due to the mixing of carbon steel and stainless steel. When these two metals come into contact with each other electrolysis occurs that breaks down the metal. The best solution is to separately wrap the carbon steel instrument to insulate it from other instruments on the tray and the tray itself.

7. Operating Instructions

7.1 Turning on the Device

Plug the power cord into the socket on the rear panel of the autoclave (see the rear view) and into the wall outlet.

Turn ON the semi-automatic ON/ OFF bottom Switch located on the rear panel of the autoclave.

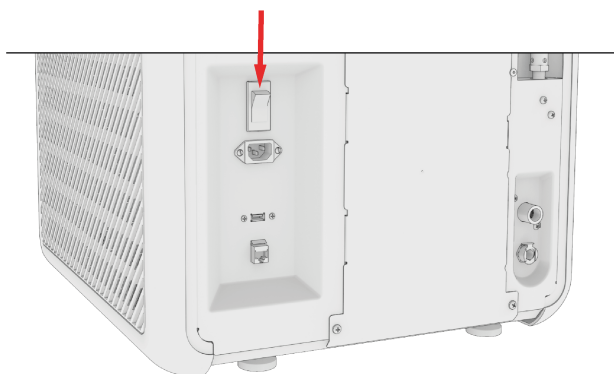

Turn ON the ON/OFF switch mounted under the cover on the front of the autoclave.

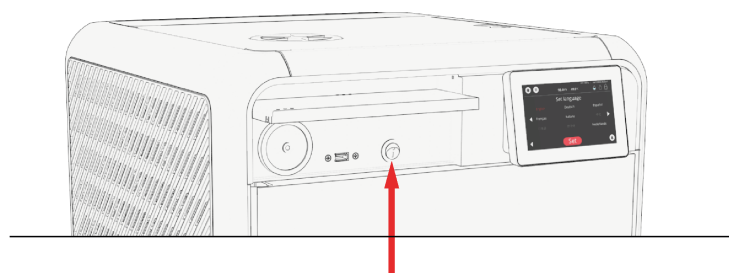

7.2 Filling Water

Cautions!

In the beginning of each day, check the water level in the reservoir.

Note: Improper Water level icon  appears when the water reservoir needs to be filled.

A general alarm symbol  will appear.

Proper Water level icon  appears when the water reservoir is properly filled.

The water level icon  appears when the water level in the reservoir is full.

When this icon appears, do not fill water!

The following screen shows that the Waste water tank is full.

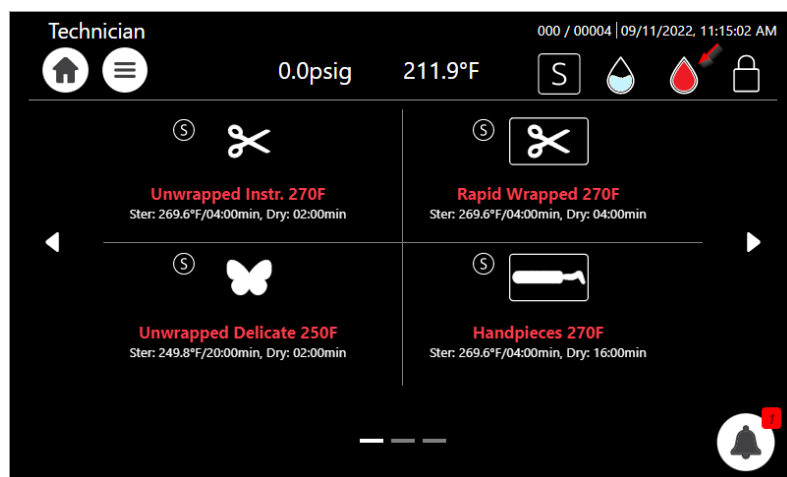

The following screen shows that the Waste water tank is empty.

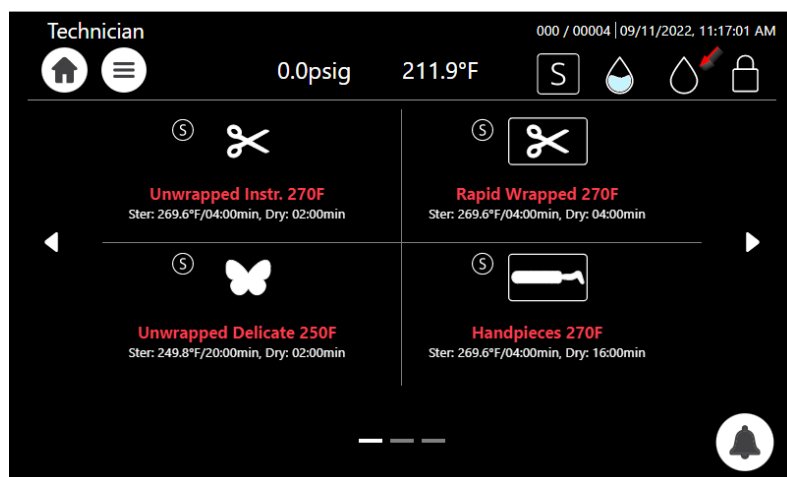

Caution! Before filling the reservoir, verify that the autoclave is idle and there is no pressure in the chamber.

7.3 Filling water in the reservoir

Note: Use only water having the characteristics stated in Water Quality. Using tap water will clog the system and invalidate the manufacturer's guarantee.

To fill water in the reservoir:

Lift up the water reservoir cover (see below).



Pour water into the reservoir through the water filter on top of the autoclave unit. In case you fill too much water, it will spill on the counter.

The clean water level indicator will change from a red water droplet symbol to a blue water droplet, as shown below:

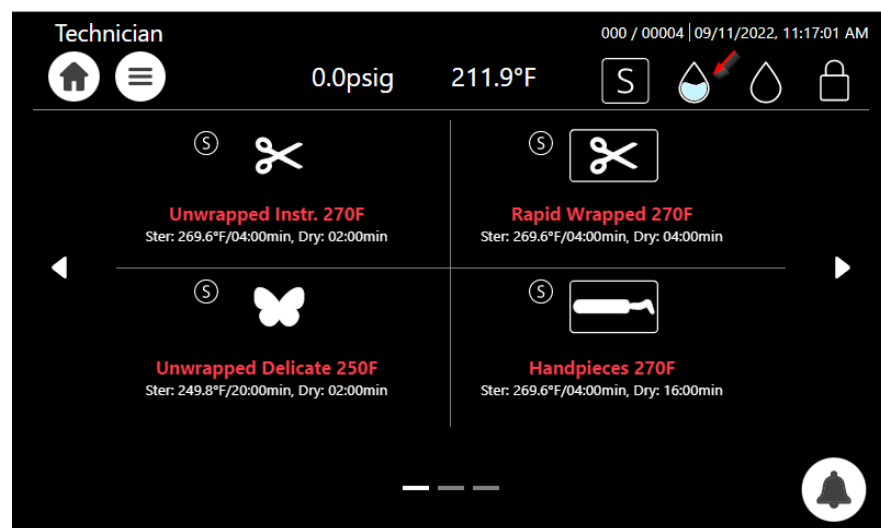

The screen below displays a full clean water tank.

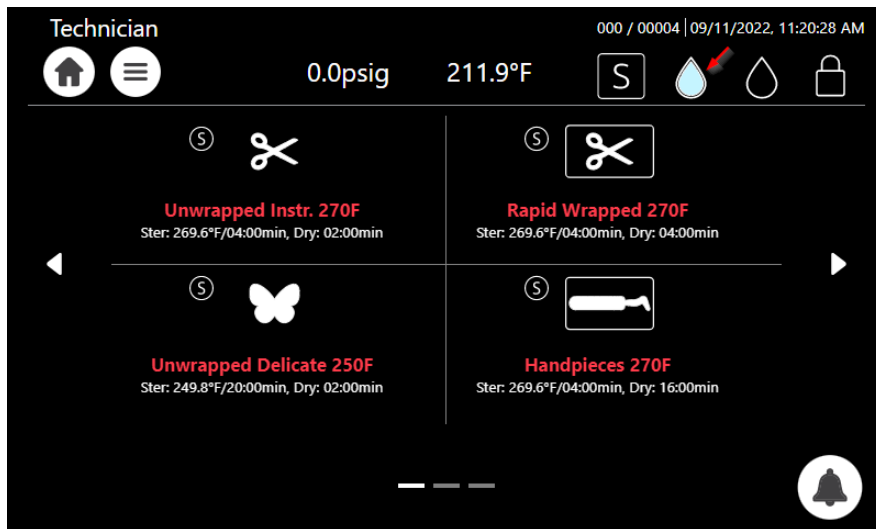



7.4 See the requirements concerning Water Quality, in Section 1.12

7.5 Setting Date and Time

Note: The Initial log-in including setting of drying time as well as other initial parameters will be performed only by a qualified technician upon installation.

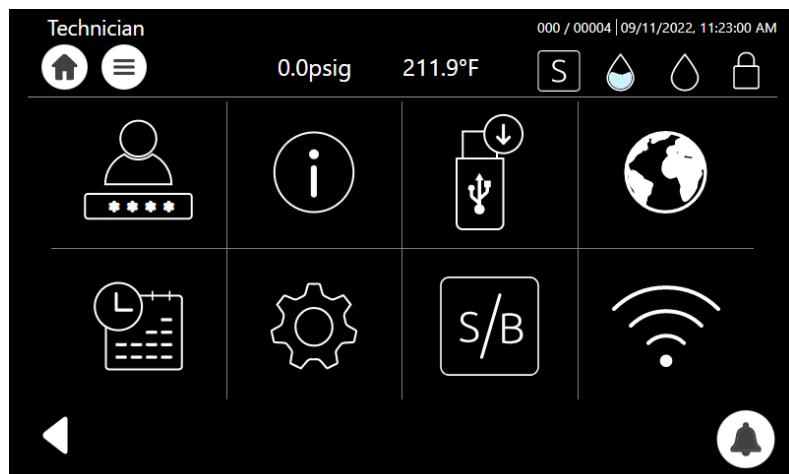
On the main screen, press the menu symbol  to open the **Quick Option** screen.



From the **Quick Option** screen, press the **Set Date and Time** icon .

Note: The only functionality to be performed by the user (on a regular basis) is setting the date and time. Select day, month and year, as depicted:

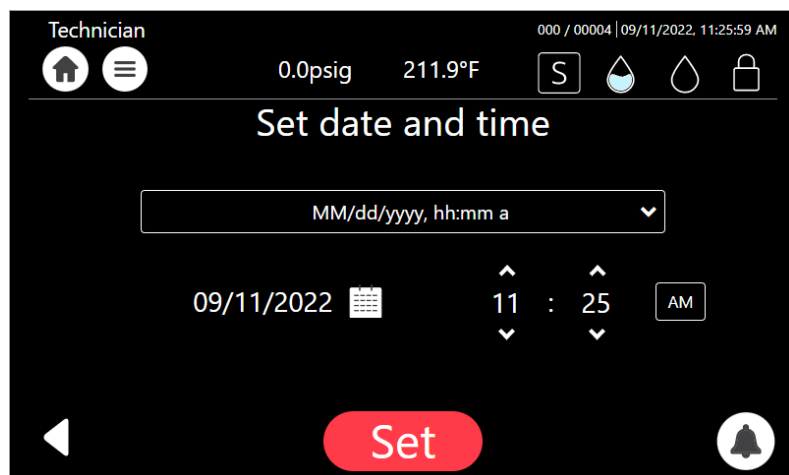

After adjusting the date and time, the system will automatically restart.

7.6 Class S and Class B

Class B: General description

Class B (that conform to the European standard) mainly provides deeper vacuum in the autoclave chamber than Class S, therefore, includes a more complete air removal from the most difficult load types. It allows the system to perform vacuum in difficult hollow or porous instruments and perform effective sterilization of these materials.

Class S: General description

Class S used in the USA obtain weaker vacuum level and is less effective than Class B in the sterilization of hollow instruments.

The following tables provide:

Table A provides the types of sterilization cycles.

Table B provides the T-Edge, Class B sterilization programs.

Table C provides the T-Edge, Class S sterilization programs.

Table A — Types of sterilization programs

| Class B | Class S |
|---|--|
| <p>The sterilization of products as represented by the test loads in the standard.</p> <p>For products that lie within the limits specified for the relevant test loads, this includes:</p> <ul style="list-style-type: none"> solid products porous products wrapped (single and multiple-layer) or non-wrapped | <p>The sterilization of products as specified by the manufacturer of the sterilizer including non-wrapped solid products and at least one of the following:</p> <ul style="list-style-type: none"> porous products, small porous items bowls and receivers single-layer wrapped products multiple-layer wrapped products |

Table B — Class B: sterilization programs

| | Cycle Name | Sterilization Temp. |
|---|-------------------------|---------------------|
| 1 | Unwrapped Instr. 273F | 273.2°F |
| 2 | Wrapped Pouches 273F | 273.2°F |
| 3 | Unwrapped Delicate 250F | 250°F |
| 4 | Wrapped Delicate 250F | 250°F |
| 5 | System Clean | N/A |
| 6 | Bowie and Dick | 273.2°F |
| 7 | Vacuum test | N/A |

Table C — Class S: sterilization programs

| | Cycle Name | Sterilization Temp. |
|----------|-------------------------------|----------------------------|
| 1 | Unwrapped Instr. 270F | 269.6°F |
| 2 | Wrapped Pouches 270 F | 269.6°F |
| 3 | Unwrapped Delicate 250F | 249.8°F |
| 4 | Handpieces 270F | 269.6°F |
| 5 | System Clean | N/A |
| 6 | Rapid Wrapped Pouches 270F | 269.6°F |

7.7 Setting Class S and Class B

Your autoclave contains Class S as a standard. If you (the customer) would like to upgrade your system to a Class B, please contact Tuttnauer USA representatives or your dealer. Tuttnauer will ask you for the Class type factor (accessible from the S/B screen). In return Tuttnauer will provide you with a code/password.

After entering the new code password by the customer user, the autoclave will contain now the Class B features.

The following details the procedure to access Class B and how to switch from Class S to B, and from Class B to S.

1. From the **Quick Option** screen press  to select Class B.

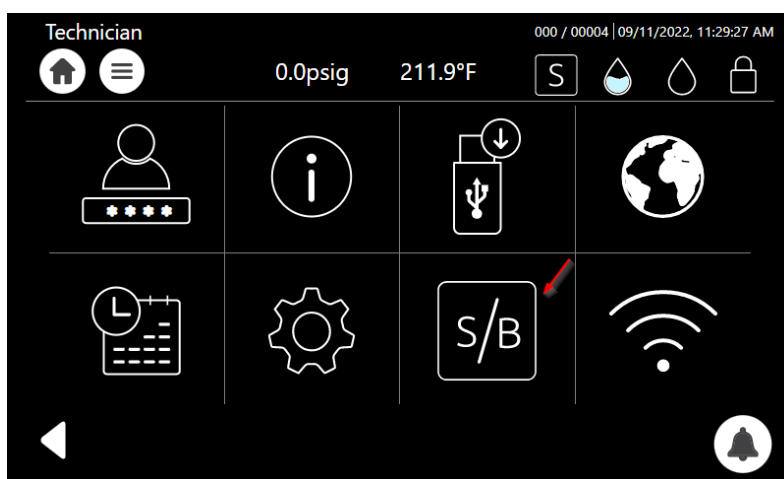

Note: The autoclave presently is in Class S.

2. Press on the required class  type, enter your **Password**, and press **Set**.
3. The **Class Settings** success screen is displayed.

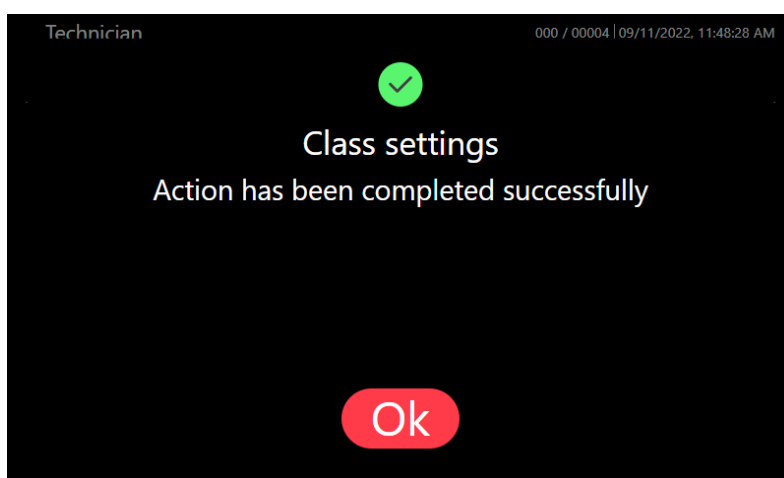

2. Press **Ok** to complete conversion.

The autoclave is now converted to Class B and the screens displayed will have a Class B identification.

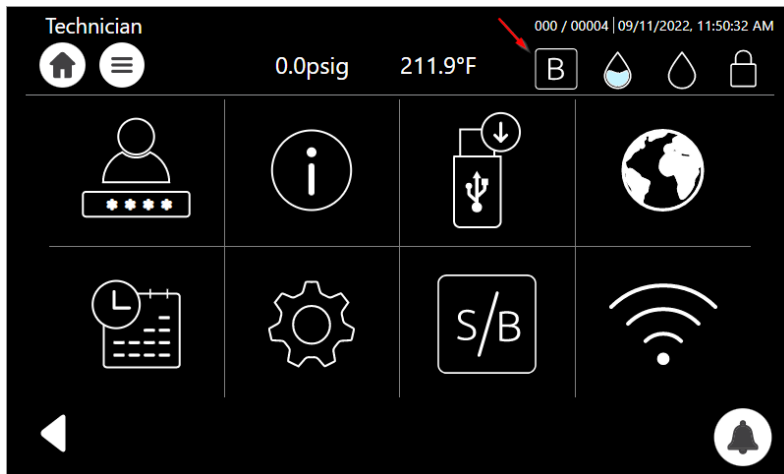

Note: The Class B sign is on the screen header.

The entire autoclave is now in Class B system, a sample of the screens after the conversion to Class B, are shown below:

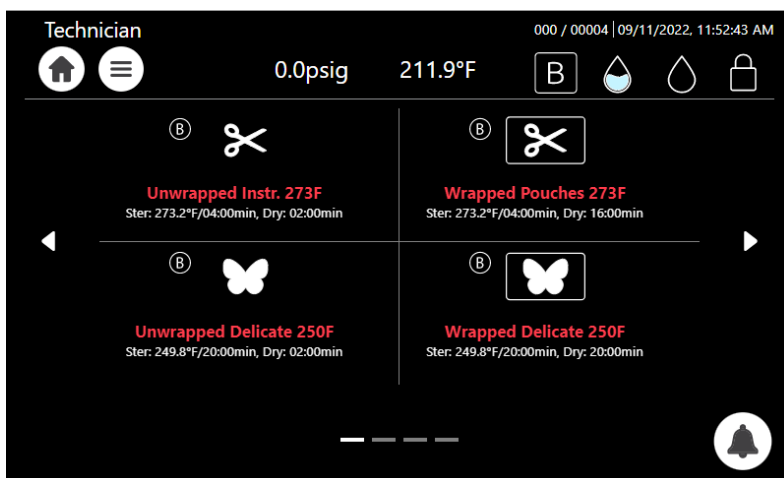

Note: It is possible to switch back from Class B to Class S if desired, following the steps above, by selecting S in step 3 above instead of S&B. Entering the code password is required.

8. Control Panel

The display is a graphic Touch screen LCD panel used to display the autoclave current status, any Operational or Error Messages and for operating the machine.

Image 1: Home screen –Program Select Screen



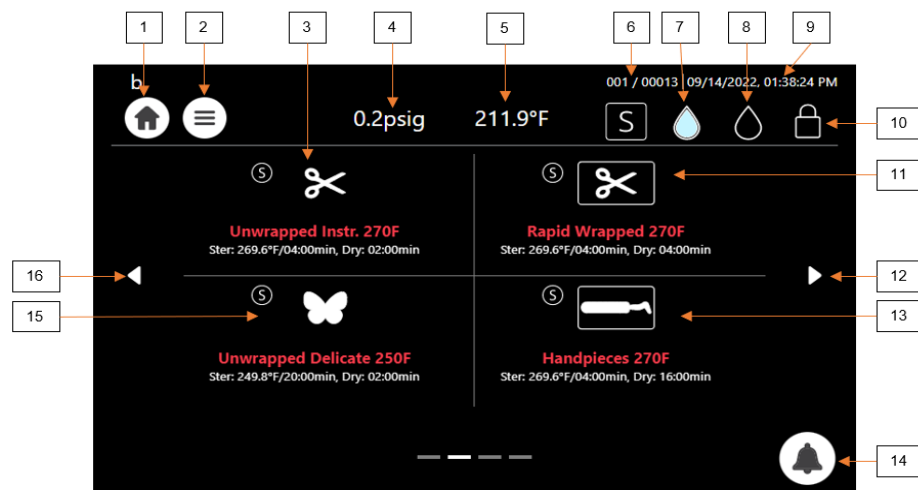



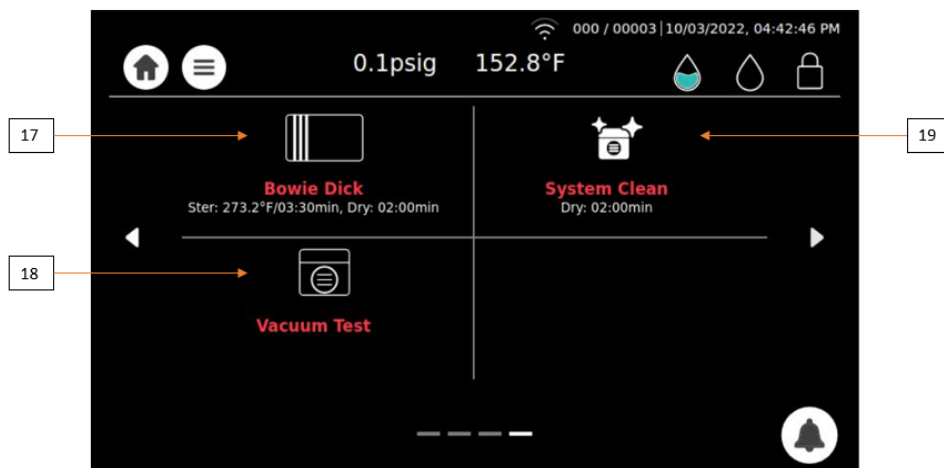



This screen will be presented when the autoclave is switched on:

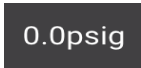



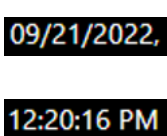







Additional programs are accessible by paging using the side arrows:



8.1 Home screen Description and Functions

| # | Icon | Name | Description |
|----|---|---|--|
| 1 |  | Home icon | Main screen selection icon |
| 2 |  | Menu | Menu selection icon |
| 3 |  | Unwrapped Instr. 270F | Unwrapped Instruments 269.6°F load program |
| 4 |  | Pressure | Momentary Pressure in the chamber |
| 5 |  | Temperature | Momentary temperature in the chamber |
| 6 |  | Counter no. ID | Daily / General counters |
| 7 |  | Full water level (clean water tank) | The Water is full in the reservoir |
| 8 |  | Empty water level (waste water tank) | The Water is empty in the waste reservoir |
| 9 |  | Date and time | Momentary date and time |
| 10 |  | Door condition | Door is closed |
| 11 |  | Rapid Wrapped 270F | Wrapped Pouches 269.6°F load program |
| 12 |  | Side arrow right | Paging forward to the next programs |
| 13 |  | Handpieces 270F | Handpieces 269.6°F load program |

| # | Icon | Name | Description |
|----|---|-------------------------|---|
| 14 |  | Warnings | Indicates the Alerts |
| 15 |  | Unwrapped Delicate 250F | Unwrapped Delicate 249.8°F load program |
| 16 |  | Side arrow left | Paging backward to the previous programs |
| 17 |  | Bowie and Dick Test | Periodic testing as referred to in ISO 17665-1 |
| 18 |  | Vacuum Test | See description in sec. 8.5.4 |
| 19 |  | System Clean | System Clean program cleans the autoclave chamber and the water and steam piping |
| 20 |  | Custom | Duplicates a sterilization program and enables modifying the settings. Note: This is not an FDA approved program! |
| 21 |  | Virus Protect | The Virus Protect program is selected prior to a sterilization program to ensure that viruses are eliminated |
| 22 |  | Add Extra Dry Time | Enables the option of adding extra dry time to a program |
| 23 |  | Start Cycle By Clock | Gives an option of starting a cycle by clock |

8.2 Opening the Device Door

This machine is equipped with an electronic door lock. The door is locked when either the system is running a sterilization cycle, or there is pressure in the chamber, or the power is off.

If you need to open the door after cycle completes, press **Confirm**:

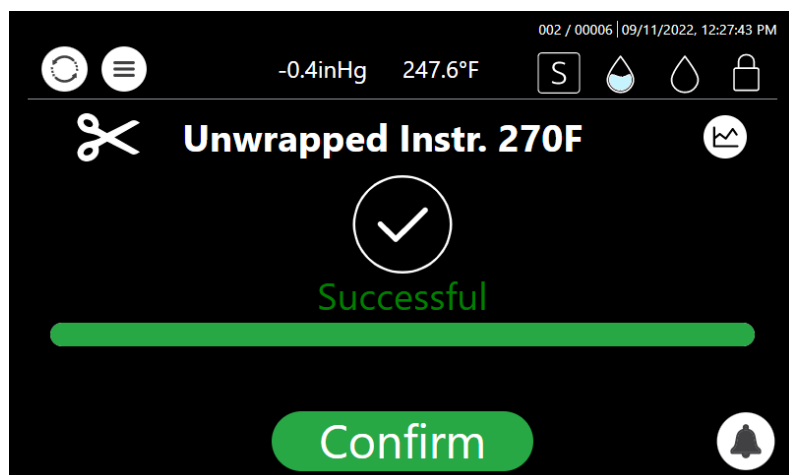

If the door is not locked, it can be opened as illustrated below.

Turn the handle counterclockwise and pull out to open the door.



Opened position

Green light



Closed position

8.3 Starting a Cycle

It is recommended to perform B&D test cycle at the beginning of each working day.

1. Before each cycle, check visually that the gasket is intact, not loose and clean.
2. Load the autoclave properly (see chapter 6).
3. Choose the appropriate sterilization program.
4. Each sterilization program screen contains a **Virus Protect**  option.

Notes:

- The program can only be selected when the door is open.
 - The Virus Protect is not for use for Textile and Porous programs
5. The selected programs are shown below:

Class B

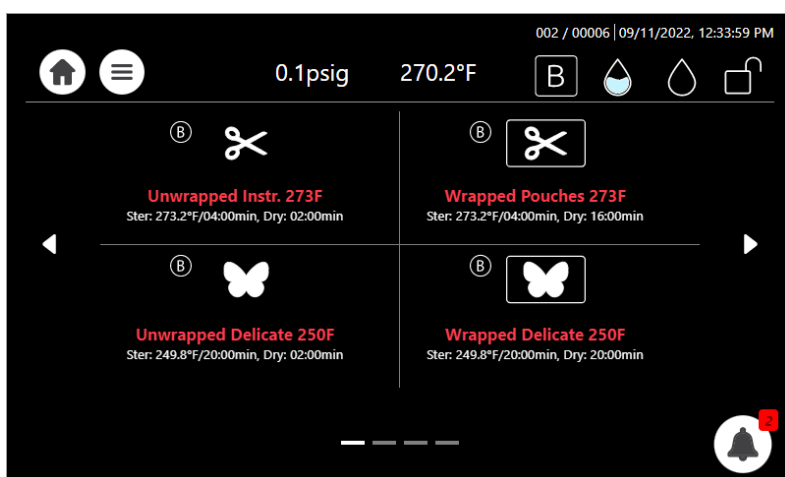

Class S

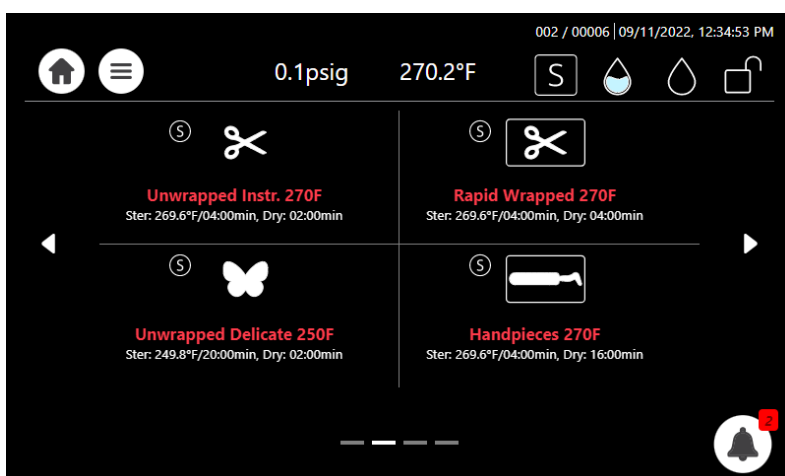

See section 8.5 for available sterilization and test programs.

6. The next screen will prompt the selected program information.

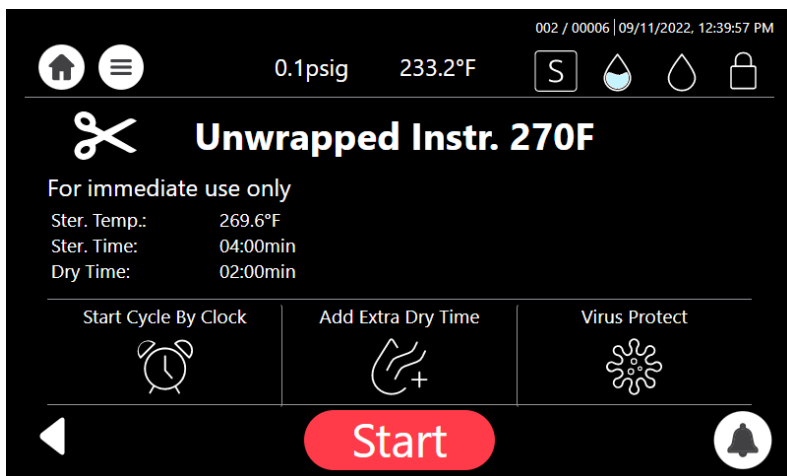

7. Close the door by both:

- Pushing the door gently;
- Turning the handle clockwise while pushing the door until it comes to the closed position, then releasing the handle.

When the door is closed, the open-door symbol  is replaced with the closed-door symbol .

8. Press the  button to start the cycle.

For cycle process description, see Sterilization Cycle Description.



Warning!

Do not remove the top cover during a running cycle. Hot water / steam may exit!

After pressing start, the sterilization process starts

Image 3: Screen display while "Unwrapped Instr. 270F" sterilization program is in progress.

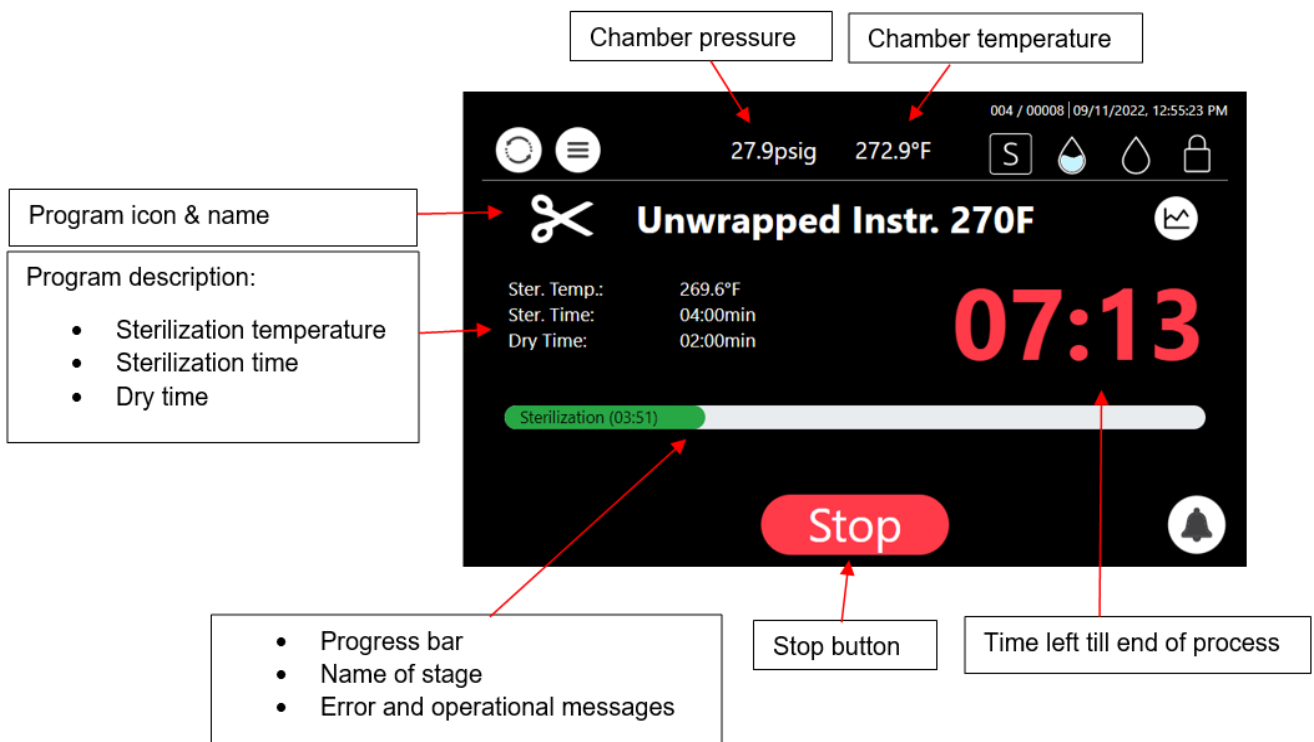

Note: For the results of the cycle, see description in section 8.5

8.4 Virus Protect program

The **Virus Protect**  is a program that eliminates viruses and is performed prior to a sterilization cycle.

Note: The Virus Protect is not for use for Textile and Porous programs.

1. Select from a sterilization cycle, the **Virus Protect** option.

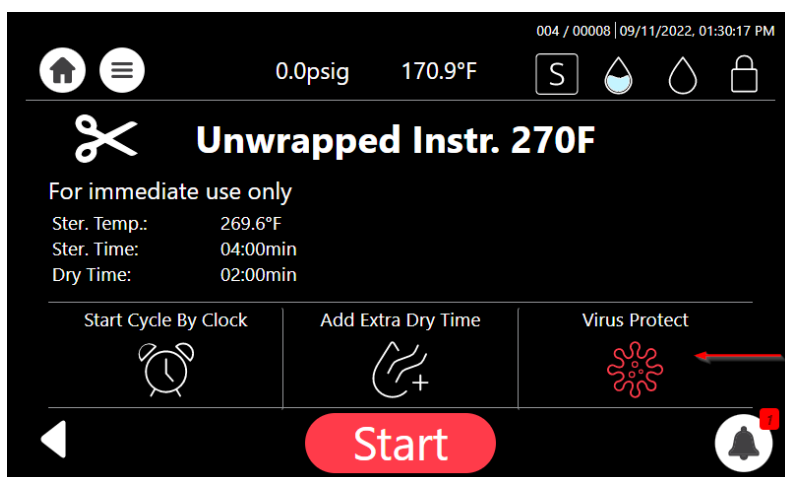

2. Press **Start** . When the cycle starts, raise the temperature to 230°F (110°C) and wait for a period of 10 minutes for the Virus Protect process to complete, and if, for example, the Unwrapped Instr. sterilization program is selected, the screen below is displayed if the virus protect is successfully completed.

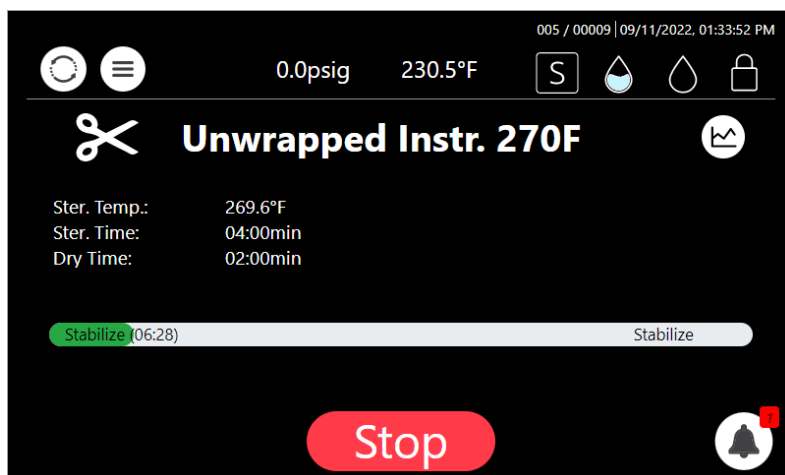



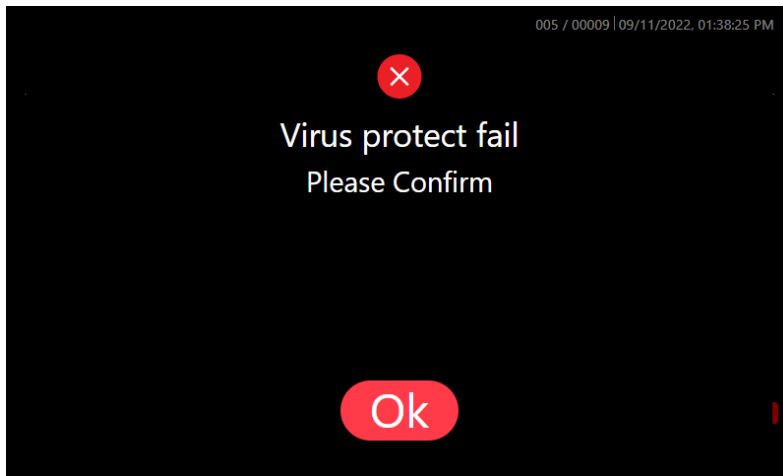



Note: If the Virus Protect program fails, the confirmation message below appears. After pressing on OK in this message, the system will release air outside of the autoclave.



8.5 Available Sterilization Programs and Test Programs

8.5.1 List of available Sterilization and Test Programs

Class B

| # | Icon | Name | Temp | Sterilization time (minutes) | Dry time (minutes) | Load type | Type of use |
|---|---|-------------------------|---------|------------------------------|---|---|--|
| 1 |  | Unwrapped Instr. 273F | 273.2°F | 4 | 2 (default) Range: 0-99 | Unwrapped Instruments (Unwrapped Solid) | Immediate use only |
| 2 |  | Wrapped Pouches 273F | 273.2°F | 4 | 16 (default) Range: 0-99 | Handpieces, Wrapped Instruments (wrapped solid), Textile (fabric packs), porous | For storage |
| 3 |  | Unwrapped Delicate 250F | 250°F | 20 | 2 (default) Range: 0-99 | Unwrapped Instruments (Unwrapped Solid) | Immediate use only |
| 4 |  | Wrapped Delicate 250F | 250°F | 20 | 16 (default) Range: 0-99 | Wrapped Instruments (wrapped solid), Textile (fabric packs), porous | For storage |
| 5 |  | Bowie and Dick | 273.2°F | 3.5 | 2 (default) Range: 0-99 | Chemical Indicator in a product challenge device | Periodic testing as referred to in ISO 17665-1 |
| 6 |  | Vacuum Test | N/A | N/A | Vac. Stable Time 1 = 5min Vac. Stable Time 2 = 10min | Empty | Not Applicable |
| 7 |  | System Clean | 273.2°F | N/A | N/A | Empty | Periodic cleaning |

Class S

| # | Icon | Name | Temp | Sterilization time (minutes) | Dry time (minutes) | Load type | Type of use |
|---|---|----------------------------|---------|------------------------------|-----------------------------|---|--------------------------------------|
| 1 |  | Unwrapped Instr. 270F | 269.6°F | 4 | 2 (default) Range: 0-99 | Unwrapped Instruments (Unwrapped Solid) | Immediate use only |
| 2 |  | Wrapped Pouches 270F | 269.6°F | 4 | 16 (default) Range: 0-99 | Handpieces, Wrapped Instruments (wrapped solid), Textile (fabric packs), porous | For storage |
| 3 |  | Unwrapped Delicate 250F | 249.8°F | 20 | 2 (default) Range: 0-99 | Unwrapped Delicate Instruments (Unwrapped Solid) | Immediate use only |
| 4 |  | Handpieces 270F | 269.6°F | 4 | 16 (default) Range: 0-99 | Handpieces | For storage |
| 5 |  | Rapid Wrapped Pouches 270F | 269.6°F | 4 | Range: 0-99 | Handpieces, Wrapped Instruments (wrapped solid), Textile (fabric packs), porous | For low-weight loads, For storage |

Note:

At the end of the cycle, visually inspect and verify that the instruments are dry.

If moisture is detected on the instruments, increase the dry time by clicking , before restarting the cycle.

8.5.2 Maximum Load Weight per Load Type



Warning!

Do not overload! Exceeding the maximum load weight (see Class B and Class S tables below), may result in moist instruments, consequently leading the user to increase the dry time.

Class B

| Load type | Maximum load weight | | Suitable for programs |
|-----------------|---------------------|------------------|-----------------------|
| | T-Edge 10 | T-Edge 11 | |
| Textile, porous | ~3 lbs (1.5kg) | ~4.4 lbs (2.0kg) | Wrapped Pouches |
| Handpieces | 5 units | | Handpieces |
| Solid Unwrapped | ~13 lbs (6.0kg) | ~20 lbs (9.0kg) | Unwrapped |
| Solid Wrapped | ~8 lbs (3.6kg) | ~12 lbs (5.4kg) | Wrapped |

Class S

| Load type | Maximum load weight | | Suitable for programs |
|-----------------|---------------------|--------------------|-----------------------|
| | T-Edge 10 | T-Edge 11 | |
| Handpieces | 5 units | | Handpieces |
| Solid Unwrapped | ~11 lbs (5.0kg) | ~17.6 lbs (8.0kg) | Unwrapped |
| Solid Wrapped | ~8 lbs (3.6kg) | ~9.9 lbs (4.5kg) | Wrapped |

8.5.3 Description of the Sterilization Cycle Stages

Air-removal stage: Pre vacuum pulses are performed. For wrapped cycles, there are 2-3 pulses and the vacuum are deeper.

Heating stage: steam is inserted into the chamber until the sterilization temperature is reached.

Sterilization: sterilization temperature is maintained constant during the sterilization time.

Exhaust: steam is exhausted out of the chamber at a fast rate until pressure decreases to ambient pressure.

Drying: performed with the door closed by pulling vacuum and using the accumulated heat in the chamber and the load to remove leftover moisture from the instruments and wraps.

8.5.4 Description of the Vacuum Test Stages

Vacuum is produced in the chamber, down to P1=2.17 psi (15 kPa.) At this stage all the valves close. The autoclave remains in this stage for 5 minutes. This period enables the condition in the chamber to reach equilibrium. After the 5 minutes have elapsed, the cycle 'history record' records the pressure that is referred to as P2. At this point the test begins and lasts 10 minutes. At the end of the test, the cycle 'history record' records the results. The pressure at the end of the test is referred to as P3.

Notes:

- During the test period the autoclave is not heated. Even if the vacuum test is completed, the operator shall check the test results and consider whether the test results are acceptable or not.
- Perform the Vacuum Test on a completely dry chamber. Preferably following a cycle with a Drying procedure i.e., a Wrapped cycle, and after the Chamber was cooled i.e., Sleep mode/Turned off.

8.5.5 Description of Bowie-Dick Test Stages

Air-removal stage: vacuum pulses are performed.

Heating stage: steam is inserted into the chamber until the sterilization temperature and pressure are reached.

Sterilization stage: temperature and pressure are maintained constant at the pre-set level for sterilization time.

Fast exhaust stage: steam is exhausted out of the chamber at a fast rate until pressure decreases to ambient pressure.

Drying stage: heating of chamber followed by a vacuum break (air inlet) to remove leftover moisture from the instruments and wraps. Air inlet to reach atmospheric pressure.

8.6 Cycle Succeeded / Cycle Failed Notifications and Follow-on

8.6.1 Cycle Succeeded

When the cycle has ended successfully, the following "Successful" message is displayed:

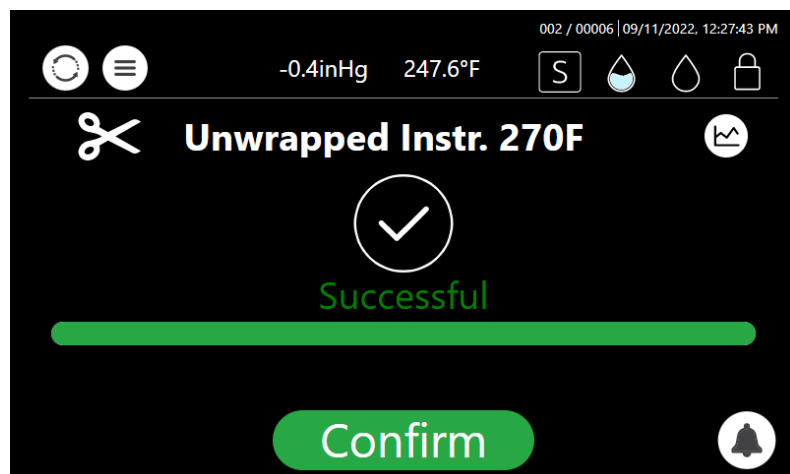

Push the confirm button **Confirm** to confirm the "Successful" message. Proceed to chapter "Opening the door and Unloading".

8.6.2 Cycle Failed

In the event of a failure at any stage, the exhaust valve will be opened to release pressure from the chamber, the message "Fail" and a relevant failure message will be displayed on the screen:

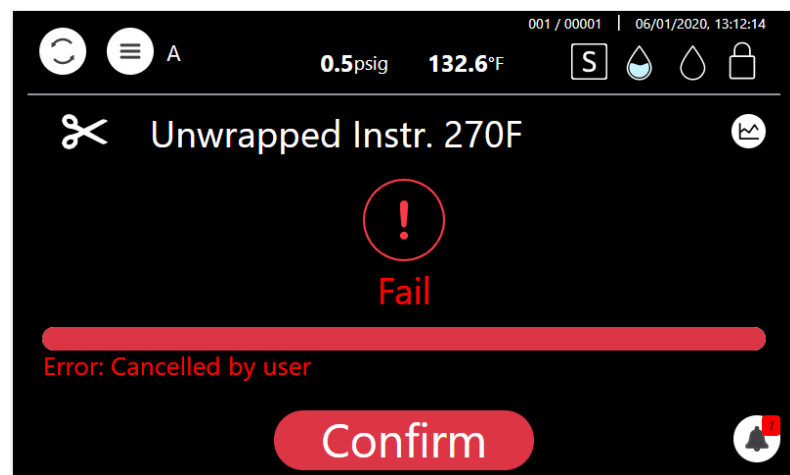

 **Warning!**

The load has not completed a sterilization cycle; therefore, it is not sterile. Handle it as a contaminated load.

Any failure means that the load is not sterile.

8.7 Aborting a cycle

It is possible to stop the cycle while the autoclave is operating. Press **Stop** at any stage (except exhaust) of the process to stop the operation.

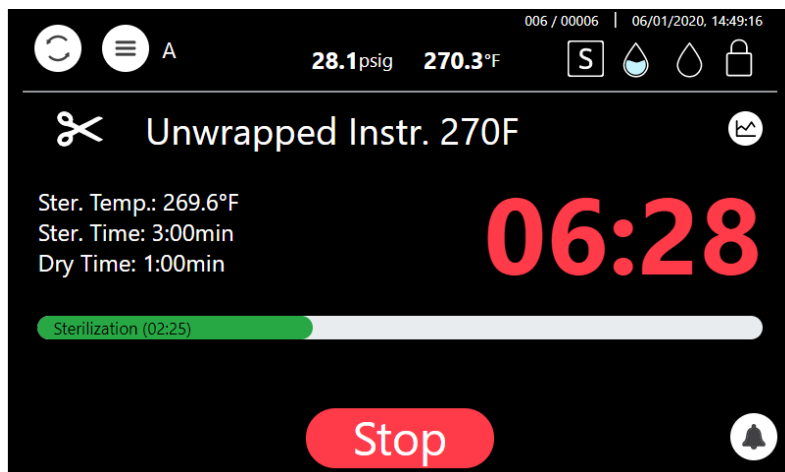

If the cycle is aborted, the load is not sterile. A “fail” message will be displayed with an error message explaining the reason for the failure. An alternating buzzer signal will sound to notify the user.

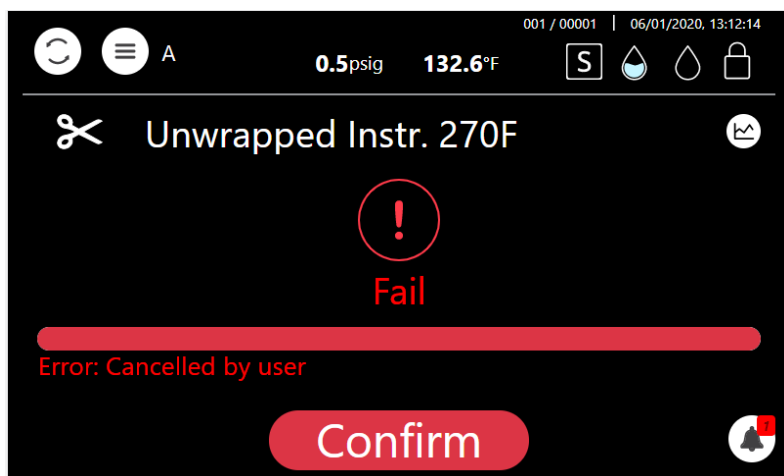

Press the **Confirm** button to confirm the displayed message.



The load has not completed the cycle; therefore, it is not sterile. Handle it as a contaminated load.

8.8 Custom Programs



Custom programs are not FDA approved!

Validation of the sterilized cycle is the user's responsibility.

The T-Edge autoclave offers the user a customized program, adjusted in order to sterilize items that cannot be sterilized in any of the preceding default programs.

To utilize a customized program:

Have your dealer or service technician create a customized program. This can be done by duplicating one of the preinstalled programs.

The new program becomes a customized program with a new name (per customer's request), a unique

icon , and specific settings are available for modification.

1. Select from the Home screen, the Custom program.

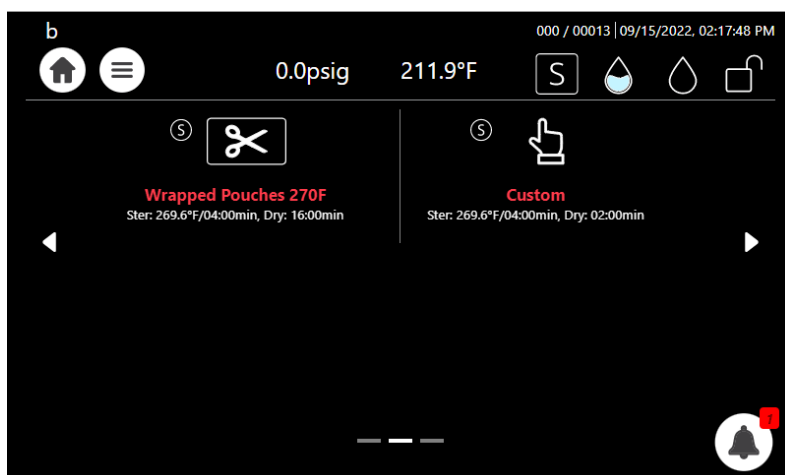

2. The Custom program is displayed below with the modified settings.

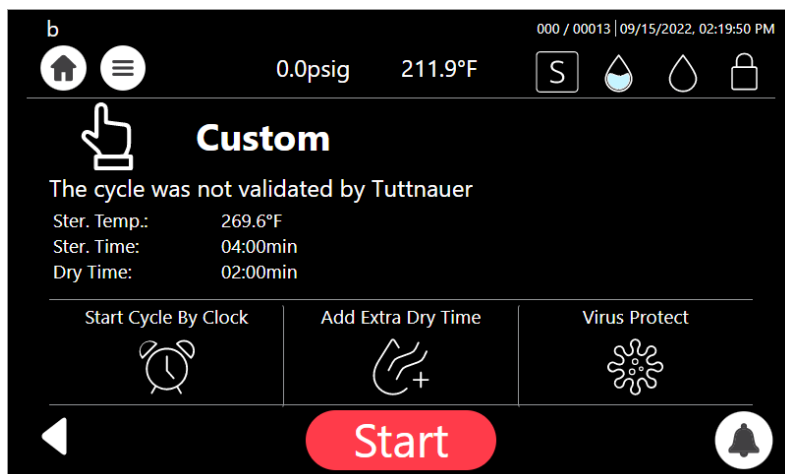

3. Press **Start** to begin the customized cycle.

8.9 Cycles history

The Cycles history menu enables printing a specific cycle.

- On the Quick Option screen, press the Settings icon , then browse to Advanced options / Handle cycles / Cycles history

The following screen is displayed with the status of the cycle.



If you select a cycle history from the screen above, a Cycle content screen appears

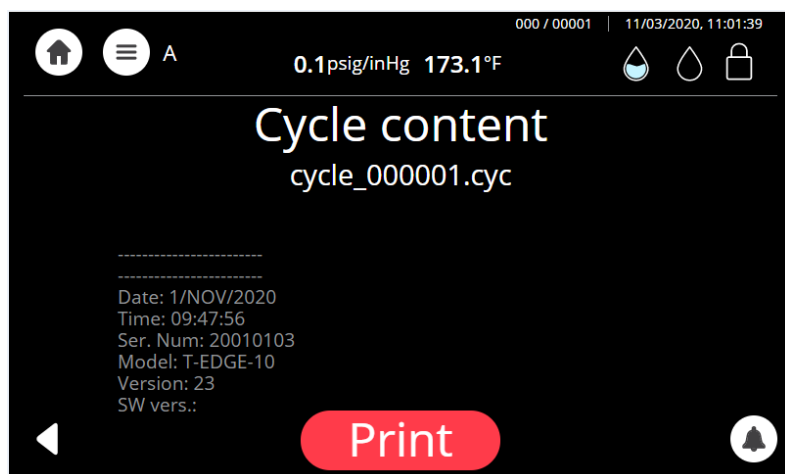

Press **Print** to receive the entire printout of the selected cycle history.

8.10 Opening the door and Unloading

1. Press **Confirm** to confirm the "Successful" or the "error" message to unlock the door.
2. Open the door.



Open the door a little to release the steam from the chamber. Only after the steam escaped, open the door widely.



To avoid severe injuries from hot steam and condensed hot water that may drip out when opening the door, it is strictly forbidden to lean on the autoclave. It is strictly forbidden to place your hand or any part of your body over or under the door.

3. Use the tray handle or wear heat-resistant gloves to remove the load from the autoclave.
4. After unloading, visually inspect the load to ascertain that it is dry, and that sterilization indicators have made the required color change.



Water droplets and visible signs of moisture on sterile packaging or the tape used to secure it, may compromise sterility of processed loads or be indicative of a sterilization process failure. Visually check outside wrapper for dryness. If there are water droplets or visible moisture on the exterior of the package or on the tape used to secure it, the pack or instrument tray is considered unacceptable.



The sterility of the instruments processed in unwrapped cycles cannot be maintained if exposed to non-sterile environment.

8.11 Checking Waste Water Level



When the waste water level is high, the general alarm symbol  will appear. A relevant text alarm will appear in the alarms list. This situation is normal, but the operator cannot run a new cycle before draining the waste water reservoir (see Draining the Reservoirs in section 8.12).

8.12 Draining the Reservoirs

This procedure applies to the mineral-free water reservoir (left) and to the waste-water reservoir (on the right).



Note: Improper Water level icon  appears when the water reservoir needs to be filled or drained. The drain valves are located on the front right side of the autoclave after the door is opened.

To drain the reservoir:

1. See item (5) with the plastic hose (6) attached to it (supplied with the autoclave).

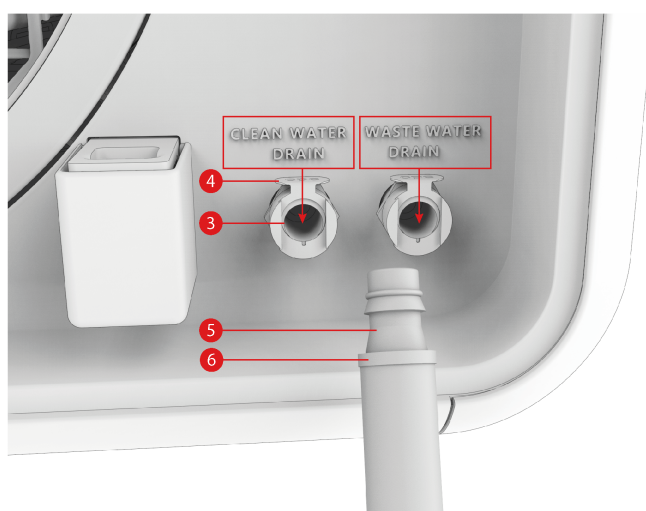

2. Put the other end of the hose into a drain bucket.
3. Insert part (5) into valve (3) and press it until you hear a click. The drain valve opens immediately.
4. When the water reservoir is empty, press part (4). Item (5) will pop out approx. 1/8"(3mm) and the drain valve will be closed. Remove item (6) with the plastic tube.



Caution! Never reuse waste water.

5. If the drained reservoir is the clean-water reservoir, fill reservoir with distilled water until it reaches the full level. (Approximately 219 Ounces /6.5 liters).

The autoclave is now ready for use.

8.12.1 Waste water draining



Caution! Waste water should be brought into the public net in accordance with the local rules or requirements i.e ONLY NON-HAZARDOUS LIQUIDS SHALL BE DISPOSED IN PUBLIC SEWAGE!

Connect the autoclave's drain to the building's drainage pipe. The drainage shall be of an open type, withstanding temperature of, at least, 140°F.

9. Preventive and Scheduled Maintenance to be performed by the Operator

The maintenance operations described in this chapter need to be followed as indicated to keep the device in good working condition and to keep any breakdown time to a minimum.

The instructions that follow can easily be carried out by the operating personnel and do not require a service technician.

Should the need arise, technical assistance or a service technician can be requested by either calling your dealer or Tuttnauer U.S.A.

9.1 Daily Maintenance



Caution!

Make sure the autoclave is not hot before cleaning it.

- Turn the unit on momentarily to allow the door to be opened. Open the door, unplug the autoclave again, and proceed with cleaning.
- Clean door gasket with a mild detergent, water and a soft cloth or sponge. Check visually that the gasket is intact, not loose and clean.

9.2 Weekly Maintenance



Caution!

Make sure the autoclave is not hot before cleaning it.

- Turn the unit on momentarily to allow the door to be opened. Open the door, unplug the autoclave again, and proceed with cleaning.
- Clean the outer parts of the autoclave with a soft cloth.

9.2.1 System Clean

Once a week perform system clean process per section 12.

9.3 Monthly Maintenance



Caution!

Make sure the autoclave is not hot before cleaning it.

- Turn the unit on momentarily to allow the door to be opened. Open the door, unplug the autoclave again, and proceed with cleaning.
- Clean and descale the chamber.
- If the autoclave is only used occasionally, drain the water from the mineral free water reservoir once a week, and refill with fresh mineral-free water or distilled water.
- Once a week or if a text alarm of 'full waste water reservoir' appears (whichever comes first) drain the water from the waste water reservoir.
- Clean the outer parts of the autoclave with a soft cloth.
- Clean the Drain filter of the autoclave.

9.4 Periodic Maintenance



Caution! Make sure the autoclave is not hot before cleaning it

1. Replace the air filter, every 6 months or after 1000 cycles (whichever comes first).
2. Every 3 months check the door gasket for any signs of physical damage and ask the technician to replace it if there is tear or leakage.

9.4.1 Replacing the Air Filter

Before proceeding, make sure that the electric cord is disconnected and there is no pressure in the chamber.



Use scissors to open the filter bag and not sharp blades or pointed instrument.

Check that the new filter has not exceeded the maximum shelf life.

Cautions! Carefully un-pack the new filter and examine it for any signs of damage.

Remove any protective packaging before inserting the filter into place.

Carefully Insert the new filter into the housing. Do not force.

The AIR filter is located under the mounted cover.

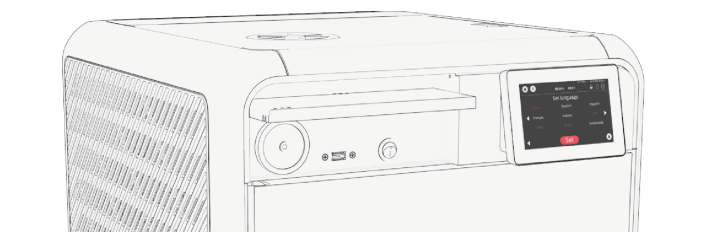

1. Unscrew the filter .

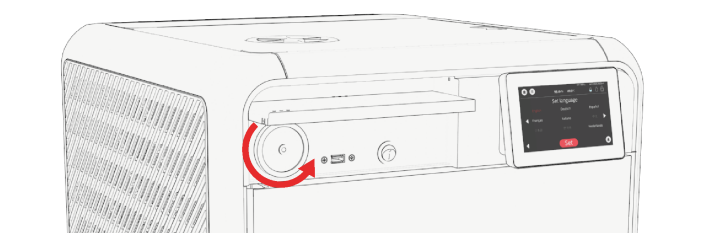

2. Disconnect the pipe.
3. Connect the new filter.
4. Screw in the new filter.
5. Ensure the new filter is all the way in and seated properly.

Note: Make sure that the arrow on the filter body points inwards, toward the chamber. Make sure that you don't bend the filter pipe when reattaching it.

9.4.2 Cleaning the Drain Filter



Cautions!

Make sure the autoclave is not hot before cleaning it

Before proceeding, make sure that the electric cord is disconnected and there is no pressure in the chamber.

1. Clean the drain filter every month.

The DRAIN filter (1) is located inside the autoclave chamber at the bottom far end, to reach the filter open the autoclave chamber door, remove the tray (see below).

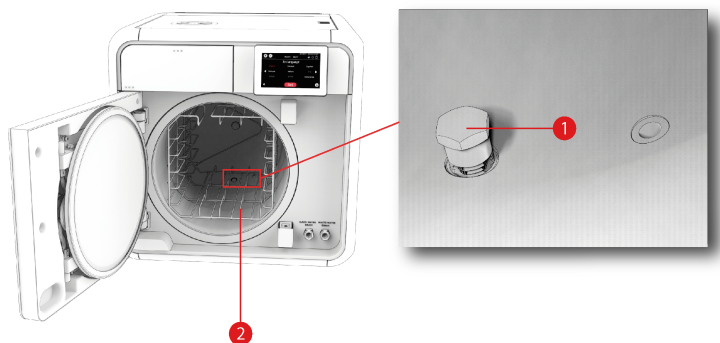

2. Open the autoclave chamber door and remove the tray (2), (see above).

3. Clean with a soft cloth the filter and the area around the filter.



4. Check that the autoclave function normally after the drain filter cleaning.

Note: If by cleaning the filter the result is not satisfactory, proceed to the replacement of the drain filter. (paragraph 9.4.3).

9.4.3 Replacing the Drain Filter

Note: If after successive cleaning of the filter the result is not satisfactory proceed to the replacement of the drain filter.



Cautions!

Before proceeding, make sure that the electric cord is disconnected and there is no pressure in the chamber.

Use scissors to open the filter bag and not sharp blades or pointed instrument.

Check that the new filter has not exceeded the maximum shelf life.

Carefully un-pack the new filter and examine it for any signs of damage.

Remove any protective packaging before inserting the filter into place.

Carefully Insert the new filter into the housing. Do not force.

 **Caution! Make sure the autoclave is not hot before cleaning it**

The DRAIN filter (1) is located inside the autoclave chamber at the bottom far end, to reach the filter open the autoclave chamber door, remove the tray (see below).

1. Replace the old DRAIN filter, by the new DRAIN filter (P/N: CMT511-0048).
2. Open the autoclave chamber door, remove the tray (2), (see below).

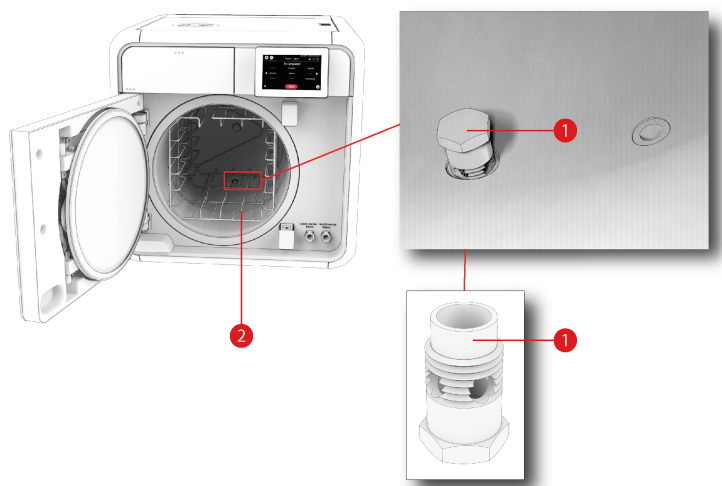







3. Unscrew the old Drain filter assembly, using M14 wrench.
4. Remove the old Drain filter assembly.
5. Screw the new Drain filter assembly, (P/N: CMT511-0048) to its place in the chamber bottom, tighten it with the M14 wrench .
6. Ensure the new filter is all the way in and seated properly.
7. Place the shelf (2) back.

10. Full List of Informative Screen Display Symbols, Operating Messages, Error Messages and Troubleshooting

The troubleshooting section is provided in order to enable the user to solve minor malfunctions, prior to contracting our service department.

However, only technical personnel having proper qualifications and holding technical documentation (including a technician manual) and adequate information are authorized to serve the apparatus.

10.1 Symbols

| Symbol / Message | Symbol / Message Description | Required Action (if applicable) |
|---|---|--|
|  | This symbol is displayed when the door is open. Note: The inherent safety feature of the machine enables the user to choose a cycle only when the door is open. | Informative symbol |
|  | This symbol is displayed when the door is closed. Note: The machine has an inherent safety feature that prevents the cycle from starting if the door is not closed. | Informative symbol |
|  | Full water level (Clean water tank) | Informative symbol |
|  | Low water level (Clean water tank) | Fill the mineral free water reservoir until this symbol changes to the proper level symbol |
|  | Proper water level (Clean water tank) | Informative symbol |
|  | Full water level (Waste water tank) | Empty the waste water reservoir |
|  | Good water level (Waste water tank) | Informative symbol |

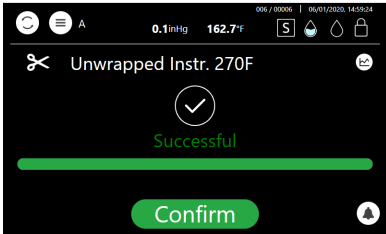
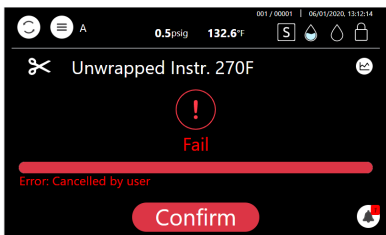
| Symbol / Message | Symbol / Message Description | Required Action (if applicable) |
|--|--|--|
|  | Alert | Press to watch the alert description |
|  | The "Successful" message and symbol are displayed when the cycle ends successfully. | — |
|  | The "Fail" message and symbol are displayed when the cycle failed either due to intended cycle abort action by the user, or due to a run-time error. | Try performing a new cycle in order to sterilize the load. |

10.2 Error Messages & Troubleshooting

| Message | Description |
|------------------------------------|--|
| "Analog Input Error" | This message is displayed when any analog input (such as a Temperature sensor or Pressure sensor) is disconnected or out of range during the cycle. (digital value < MIN DIGITAL READING or digital value > MAX DIGITAL READING). *MIN and MAX DIGITAL READING are preconfigured in the Input-Output file per IO |
| "Chamber temperature out of range" | This message is displayed if, Chamber Temperature > StandbyChamberTempMaxLimitValue (System Parameter) -OR- Chamber Temperature < StandbyChamberTemp_MinLimitValue (System Parameter) |
| "Chamber pressure out of range" | This message is displayed if, Chamber pressure > Ambient pressure + 5% -OR - |

| Message | Description |
|--|---|
| | Chamber pressure < Ambient pressure - 5% |
| "I/O card is not connected" | This message is displayed if I/O card is disconnected (while a cycle is running or not) |
| "Chamber low temperature error" | This message is displayed if the temperature drops below the sterilization temperature - Chamber Low Temperature Gap parameter during the sterilization cycle (stabilize stage) |
| "Chamber high temperature error" | This message is displayed if the temperature rises above sterilization temperature + Chamber High Temperature Gap parameter during the sterilization (stabilize stage) |
| "Chamber Low Pressure" | This message is displayed if Chamber Pressure drops below the sterilization pressure - Chamber Low Pressure Gap during the sterilization (stabilize stage) |
| "Chamber High Pressure" | This message is displayed if Chamber Pressure raises above Chamber High Pressure Gap + sterilization pressure during the sterilization stage |
| "Time Error" | This message is displayed if the real-time clock is faulty. Check the HW time and System time during sterilization and raise an error if the difference is above 10 seconds |
| "Door is open" | This message is displayed when the door is open |
| "Canceled By User" | This message is displayed after the STOP button is pressed and the cycle aborted |
| "Air Inlet Error" | This message is displayed on the standby stage if the autoclave does not reach the atmospheric pressure after 5 minutes |
| "Mineral free water reservoir empty" | This message is displayed if the water level is low in the clean water reservoir and is not sufficient for at least one cycle. The message will appear in the error messages. |
| "Routine cycle service is recommended Please call your service provider." | This message is displayed if, The number of cycles since the last periodical maintenance, exceeded the "cycle service counter" parameter, -OR- |

| Message | Description |
|--|---|
| | Time elapsed exceeded the "time service counter" parameter |
| "Power Down" | This message is displayed if power down has occurred during the cycle. The message will appear in the next power up. (this message will be printed after the autoclave is turned on) |
| "Pressure time error" | This message is displayed if Vacuum pressure fails to reach the required value (parameter Target Pressure) within the required time (parameter Pressure Time Error) in Vacuum pulse stage (Remove Air) |
| "Water fill Error" | This message is displayed if the water filling valve is On for timer > Parameter Auto Fill Water Valve Time out and Max. the float switch is not On |
| "Water tank filling, Please wait" | This message is displayed if Water Level is above parameter (Water Detection Value) value and parameter Auto Fill Water Valve Time > 0 (Auto fill) |
| "Please fill water tank to full for start" | This message is displayed if High consumption water cycle (like Prion) is selected and manual water filling is set (parameter Auto Fill Water Value Time) and the water tank is not full. |
| "Unrecognized printer" (Optional with Printer) | This message is displayed in the UI, if the printer is not recognized |
| "Poor water quality" | <ol style="list-style-type: none"> 1. Read the water level from analog sensor. 3. Compare the value system parameter (Water Quality Level). 4. If value is less than parameter |
| "Set Atmosphere Pressure is Active" | Present when Reset Atmospheric pressure is requested from Technician screen. |
| "Utility issue #2 – Please switch OFF and ON machine's power switch" | This message is displayed if the main application is not uploaded |
| "CfrPart11 - None cycle can be started since no user is currently logged on" | This message is displayed if CFR-11 is on and no user is logged in |
| "Settings don't match current" | This message is displayed if settings don't match the SW version |

| Message | Description |
|--|--|
| application, Please try to load application first and only afterwards load the settings" | |
| "Virus Protect Fail – Press to Confirm" | This message is displayed if Virus Protect program was selected, but failed before Stabilize0 stage completed |
| "Exhaust Rate Error" | This message is displayed in pulse exhaust if exhaust valve = ON and pressure delta every 60sec > Parameter Exhaust rate (System parameter) |
| "Jacket heater temperature not in range" | This message is displayed if, JHT > MAX DIGITAL READING (digital value) -OR- JHT < MIN DIGITAL READING (digital value) *MIN and MAX DIGITAL READING are preconfigured in the Input-Output file per IO |
| "Pipe water heater temperature time error" | This message is displayed if PWH = ON and PWHT < parameter Pipe Water Heater Off Temperature after PWH operation timeout parameter [minutes], disconnect the PWH digital output |
| "Pipe water heater temperature rate error" | When PWH is on, check every 60sec PWHT delta. If delta is below 2C, the message is displayed |
| "Jacket heater temperature time error" | This message is displayed if JH = ON and JHT < parameter Jacket Off Temperature after Jacket Operation timeout parameter [minutes]. Applicable for all stages |
| "Jacket heater temperature rate error" | When JH is on, check every 60sec delta in JHT delta. If delta is below 2C, the message is displayed |
| "Pipe water heater temperature not in range" | This message is displayed if, PWHT > MAX DIGITAL READING (digital value) -OR- PWHT < MIN DIGITAL READING (digital value). *MIN and MAX DIGITAL READING are preconfigured in the Input-Output file per IO |

| Message | Description |
|---|---|
| "Waste reservoir is full please empty the reservoir " (Waste Water Tank is full) | When float digital input of wastewater tank is true, display the message - "Drain waste reservoir" (Waste Water Tank is full) |
| "Leak" | This message is displayed when performing vacuum test, if after 5 and 10 minutes the pressure is above the Max Pressure Gap parameter |
| "Start cycle by clock is active" | This message is displayed if the user decides to start cycle by clock. User shall select the time that cycle should be started |
| "Door opened during the cycle" | This message is displayed if the door is open during the cycle |
| "High pressure time error" | This message is displayed if the Target Pressure parameter is not reached within Pressure Timeout in steam pulse stage |
| "Since no user is currently logged on - ' Guest ' user name will appear on result label" | This message is displayed if label printer is configured and no user is logged in |
| "Internal Error" | This message is displayed if software exception occurred |
| "Utility Issue #3" | This message is displayed if I/O card was disconnected during upload |
| "Water Tank State Error" | This message is displayed when the Max Clean Water Float is ON and the Water Level is below the electrodes (< Mineral Free Water Level system parameter) |
| "System Control Ventilation Alert – please contact service" | This message is displayed when the CPU temp is above the system parameter |
| <p>Front filter replacement notifications-</p> <p>"It is highly recommended to replace the front filter"</p> <p>"Front filter effectiveness will expire in N days"</p> <p>"Please replace your front filter to preserve sterility in the chamber"</p> | <p>Expiration date is defined by adding System parameter ("Front filter days counter") to last filter replacement date, that can be found in -</p> <p>"Maintenance" > "Reset front filter days counter"</p> <p>Notification 1:</p> <p>"Front filter effectiveness will expire in N days" -</p> <ul style="list-style-type: none"> •Will appear 3 weeks before expiration date (for one day) N = 21 |

| Message | Description |
|--|---|
| | <ul style="list-style-type: none"> •Will appear 2 weeks before expiration date (for one day) N = 14 •Will appear 1 week before expiration date (for one day) N = 7 <p>POP UP: "Please replace your front filter to preserve sterility in the chamber" Will appear when date expired and appears every month after the expiration date, until reset is performed</p> <p>Notification 2:</p> <p>"It is highly recommended to replace the front filter"-</p> <ul style="list-style-type: none"> •Will appear when date expired and appears every week until reset is performed. <p>After the user replaces the front filter, he can reset the replacement date in "Maintenance" > "Reset front filter days counter"</p> |
| <p>Biological Indicators notification</p> <p>"Indicator Notification - Did the test pass?"</p> | <p>System parameter ("Indicator notification" = 1) AND System parameter ("Label printer" != 0).</p> <p>This combination of parameters defines whether to display the pop up ("Did the test pass?") at the end of the cycle, and whether to print the number of labels of successful sterilization that the user defines before cycle.</p> <p>Only If the user defines the Number of labels > 0 AND confirms that the test passed, the labels will be printed</p> |
| <p>"Exhaust error"</p> | <p>This message is displayed on the standby stage if the autoclave does not reach the atmospheric pressure after 5 minutes, and the chamber pressure is more than the atmospheric pressure</p> |
| <p>"I/O card A2D Error"</p> | <p>There are registers(flags) that indicate issues in A2D conversion on the I/O card.</p> <p>The application should recognize and notify the user about such issues.</p> <p>If flag is true for more than 3 sec (System parameter, default 3 sec, Permission Factory), The error is displayed in the active alarms : IO internal Error (No. "NUMBER OF FLAG IN REGISTER") Write error to log. Send event to cloud. Stop the cycle as needed.</p> |
| <p>"Analog input freezed"</p> | <p>Add system parameter "AI monitor time frame"</p> |

| Message | Description |
|--|--|
| | <p>(Default: 10Sec, Permission: Factory).</p> <p>If parameter = 0, feature is disabled</p> <p>If parameter >0, Monitor Temperature AI (digital) is within the time frame of “AI monitor time frame”</p> <p>If AI reading is not changed during the time frame, block all outputs</p> <p>If the issue occurs during standby, prevent the cycle from starting and show the error “Analog Input Freezed - [AI_NAME]”</p> <p>If the issue occurs during the cycle, stop the cycle and show the error “Analog Input Freezed - [AI_NAME]” Block all heater’s outputs.</p> |
| "Low disk space error" | <p>Disk space utilization should be monitored every 12 hours or on start up (writing logs).</p> <p>If the disk space is used up by more than 75%: Send telemetry Show notification to user in Active alarms</p> |
| "Door is not open" | <p>This message is displayed when the door is not open when selecting a cycle from the main menu</p> |
| "Settings will be updated after restart" | <p>This message is displayed when the upgrade setting version is imported from the network. The settings will be upgraded after restarting the device.</p> |
| "Please connect the device to Wi-Fi" | <p>This message is displayed upon powering up, but only if the Wi-Fi has not been configured and it is not the first time powering up. Pressing "Confirm" will bring up the Wi-Fi connection screen, while pressing "Cancel" will make the message disappear.</p> |

11. TSC Printer Installation (optional)

The sections below describe:

- General printer information.
- Safety instructions.
- Setting printer definitions.

11.1 General printer information

The printer(s) are optional and can be purchased/ordered from Tuttnauer by the customer.

The printer can easily be installed and connected to the autoclave following the instructions below.

The options includes:

- One printer connected to the autoclave, loaded either with thermal paper roll, or with label roll. The user can direct the printer to switch between printing on thermal paper roll or label roll.
- Two printers connected to the autoclave - one printer loaded with thermal paper roll, and the second printer loaded with label roll.

11.1.1 Printer Output:

The autoclave is equipped with a character printer, which prints a detailed history of each cycle performed. (This can be used for the record or for subsequent consideration.)

The printing is on thermal paper with a defined set of characters per line and contains important information such as some of the main following details:

- Date:, Time: , Ser. Num:., Model:., Version:.,
- Cycle Num:., Cycle Name:., Ster Temp:., Ster Time:., Dry Time:.,End Temperature

When the sterilization cycle begins the printer starts printing the above data.

After the preliminary printing, the autoclave starts performing the sequence of operations of the cycle. The measured values of temperature and pressure are printed at time intervals, according to the phase of the process, as shown in the table on the next page.

The data is printed from the bottom up, beginning with the date and ending with "Cycle Ended". For an aborted cycle, "Cycle Failed" and the Error message are printed (refer to "Displayed Error Messages/Symbols").

The printer can also print labels when loaded with label roll and printer1 is selected.

For an example of a typical printout, see below.

Note: The software version number varies according to the released version,

Operator: -----
Time: 18:35:00
Status: Successful
00:22:43 93.6 96.3
00:22:12 84.3 24.9
D 00:22:12 84.3 24.9
D 00:21:00 71.8 24.5
D 00:20:08 102.4 109.3
E 00:20:04 102.4 109.3
E 00:18:56 133.5 302.4
CLK2: 18:31:11
CLK1: 18:31:12
S 00:18:55 133.3 301.9
S 00:18:00 133.3 299.0
S 00:17:00 132.8 300.4
S 00:16:00 132.9 298.4
S 00:15:53 132.9 296.3
CLK2: 18:28:09
CLK1: 18:28:09
H 00:15:53 132.6 296.8
H 00:15:00 132.0 288.9
H 00:14:56 131.2 286.3
A 00:14:55 131.2 286.3
A 00:12:00 122.2 220.6
A 00:09:00 108.5 137.0
A 00:06:00 83.0 15.1
A 00:03:00 85.9 124.9
A 00:00:00 80.9 101.3
Time °C kPa
End Temperature: 120.0°C
Dry Time: 02:00min
Ster. Time: 03:00min
Ster. Temp.: 132.0°C
Unwrapped Instr. 270F
Cycle Num: 2
SW vers.: 6000.2103.21.3
Model: TEDGE11
User: Guest
Ser. Num: 20111704
Time: 18:12:16
Date: 21/03/2021

11.2 Safety instructions

1. Read all the instructions and keep them for future use.
2. Follow all warnings and instructions on the product.
3. Disconnect the power plug from the AC outlet before cleaning or if fault happened. Do not use liquids or aerosol cleaners. Using a damp cloth is suitable for cleaning.
4. The mains socket shall be installed near the equipment and easily accessible.
5. The unit must be protected against moisture.
6. Handle the equipment with care. Ensure the stability when installing the device, tipping or dropping could cause damage.
7. Make sure to follow the correct power rating and power type indicated on the marking label provided by the manufacturer.
8. Please refer to the user manual for maximum operation ambient temperature.



Warning! Hazardous moving parts, keep fingers and other body parts away.



Caution!

For equipment with RTC (CR2032) battery or rechargeable battery pack.

Risk of explosion if battery is replaced by incorrect type. Dispose of used batteries accordingly.



Caution!

The print head may be hot and could cause severe burns. Allow the print head to cool.



Attention!

Due to the high temperature exuding from the autoclave's upper water tank, please refrain from locating the printer or other equipment on the top cover of the device.

11.3 Setting printer definitions

To enable setting the printer, the user is required to log-in.

1. Press  to display the **Quick options** screen.

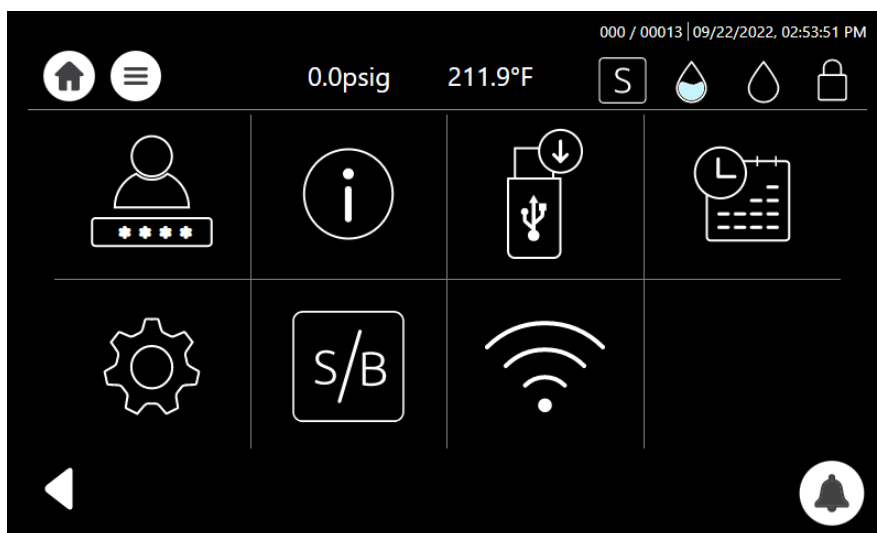

2. Press  to display the **Login** screen.

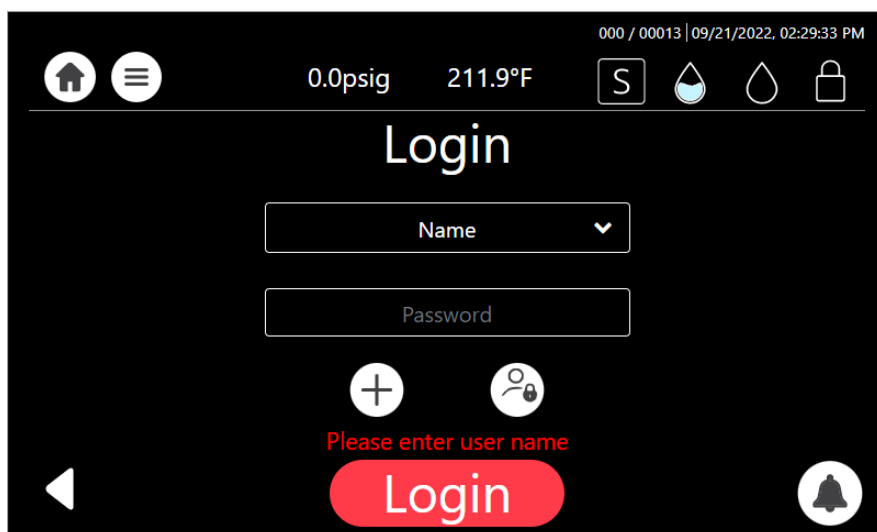

3. Enter the following information:

- **Name** - Admin
- **Password** - 0001
- **FactoryCode** - IUE0ITADS2

4. Press  .

5. Press  to display the **Settings** screen.

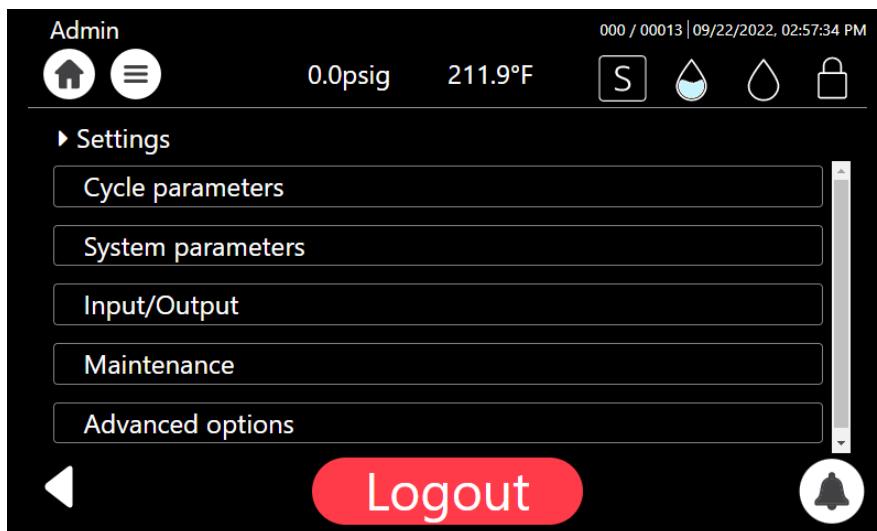

6. Browse to **System parameters/ Label printer type** or **Printer Type**.
7. Select for paper roll - Printer Type 6.
8. Select for label roll - Label printer type 1.
9. If only one printer is connected to the autoclave, local = 0 or printer = 1.

The table below, displays the various printer possibilities:

| Printer Type | Local |
|--|-------|
| Only paper roll 6 | 0 |
| Only label roll 1 | 1 |
| Both paper and label rolls are connected 6 | 1 |

12. System Clean Program

12.1 General

The System Clean program is a cleaning and descaling process for Tuttnauer's T-Edge Autoclaves.

It uses one tablet from the package - Cat#: SYSTEM CLEAN

The T-System Clean tablet is composed from chemicals that are specifically designed for cleansing and removal of water deposit oxides and other sediments that exist in the piping and Chamber of steam sterilizers.

It is recommended to perform the System Clean procedure once every 2 weeks.

Note: If your device is connected to an automatic water fill, close the inlet valve before initiating the cleaning procedure.

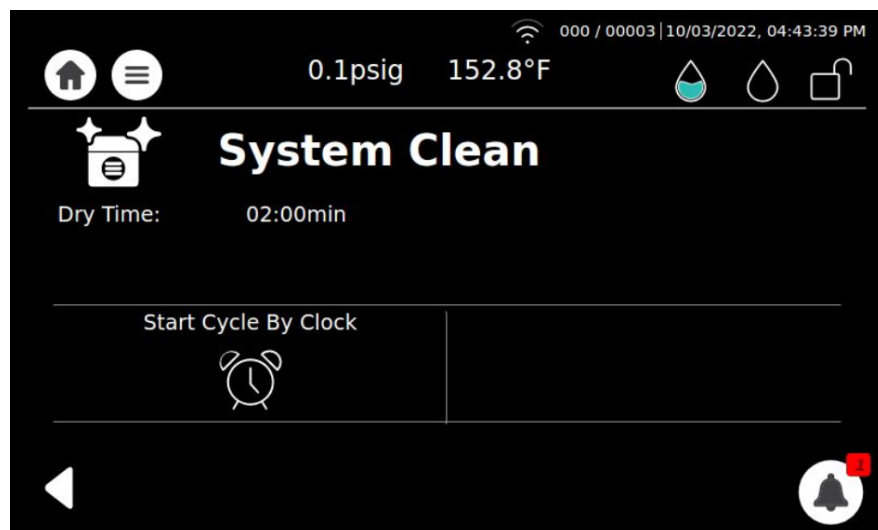

12.2 System Clean Cleaning Procedure

The System Clean cleaning program for the family of Tuttनावर's T-Edge Autoclaves is described below:

Important :

To avoid burns when removing the trays and holders, the chamber must be cold.

Use gloves to protect your hands from the chemicals.

1. All steps in this procedure must be completed without interruption.
2. Ensure there is water in the clean water reservoir and the screen indicates the proper water level ([see sec. 7.3](#)).
3. Remove the water tank cover and place one tablet (1) from the tablet packing (2) in the clean water reservoir (see below).

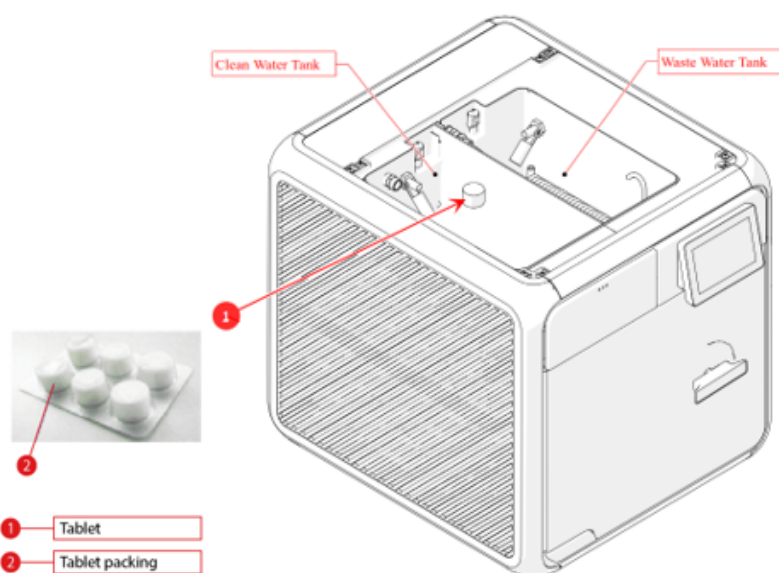

4. Open the autoclave door.
5. Select the relevant program.

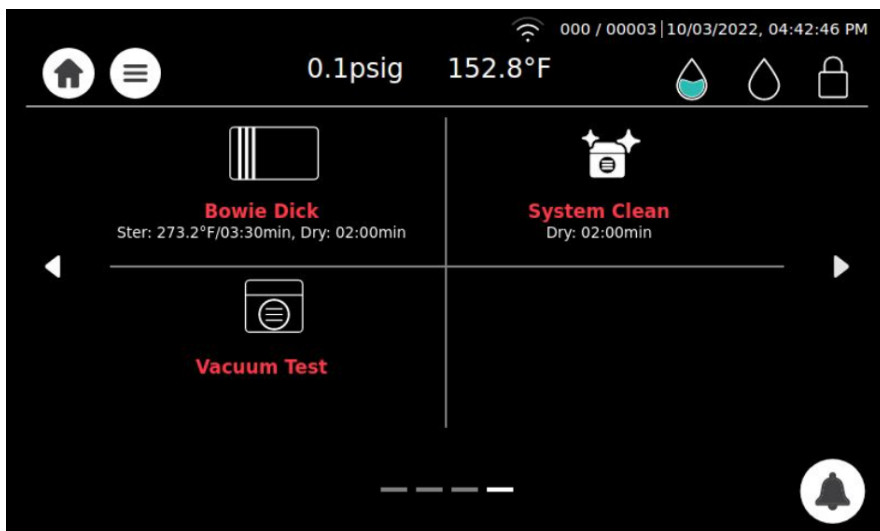

6. Remove all instruments, loads, trays and shelf holder from the autoclave chamber.
7. Place the trays and shelf holder in the sink to be cleaned with a stainless steel Safe cleaner.
8. Close the autoclave door.
9. System Clean - Start cycle.

Press **Start**.

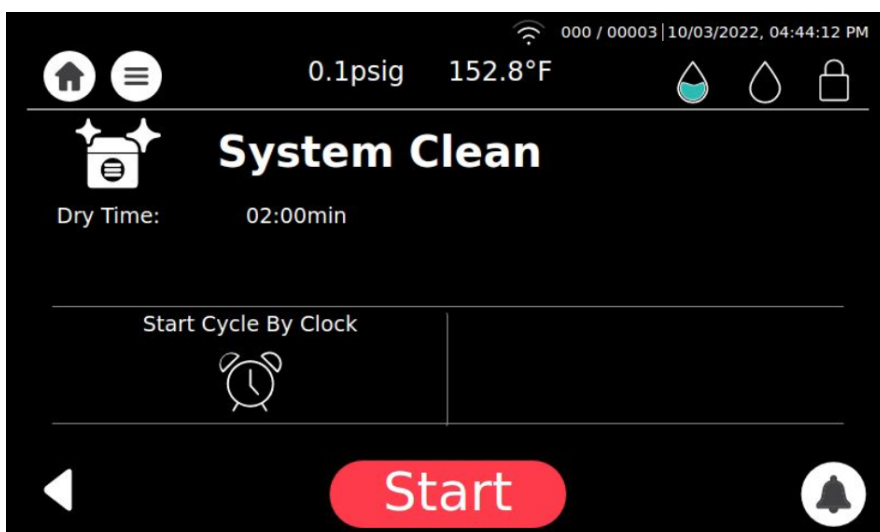

10. The cycle cleans the piping and the chamber. The System Clean process lasts approx. 25 minutes.

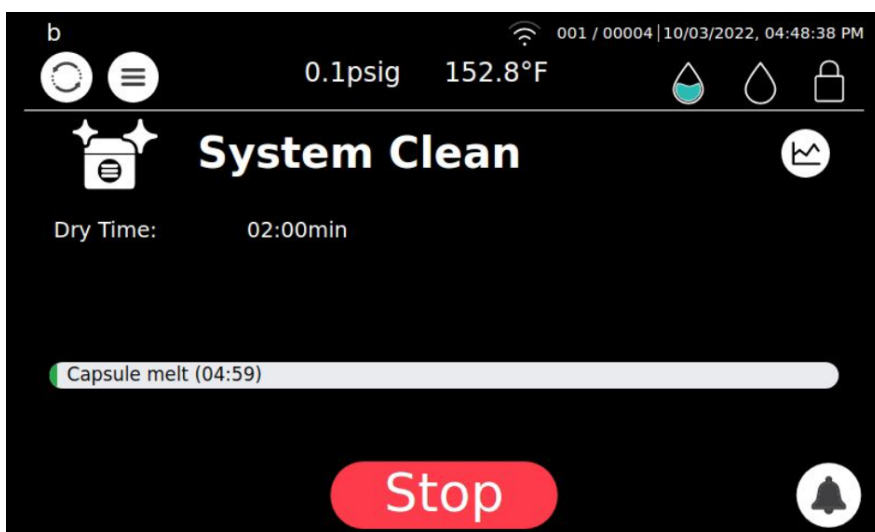

11. After approx. 25 minutes, the System Clean process is complete and the following screen is displayed.

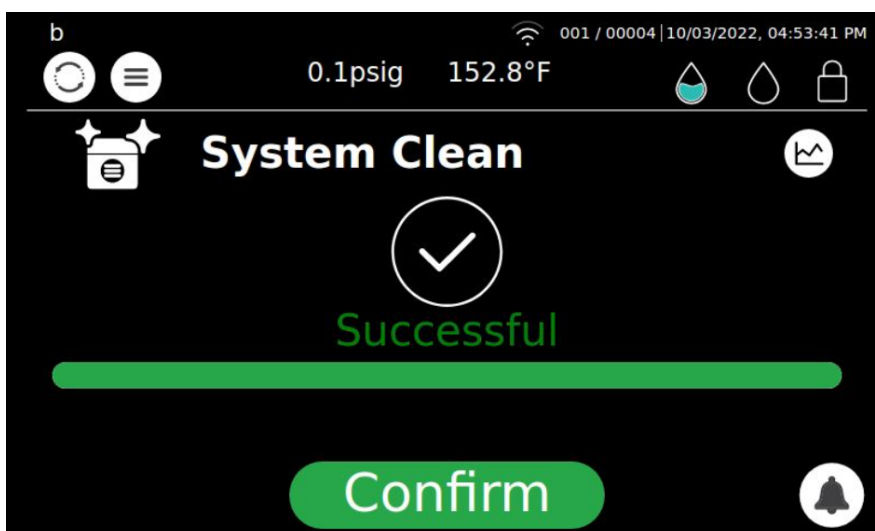

12. Upon cycle completion, follow the instructions below:

- Open the autoclave door to enable the chamber to cool
- Remove the water tank top cover
- Empty both clean water and waste water reservoirs
- Wipe the walls, bottom and the electrode of the clean water reservoir
- Wipe the walls and bottom of the waste water reservoir
- When the chamber cools completely, wipe the walls of the chamber

Note: The electrode in the clean water reservoir detects water; therefore, if the reservoir is not emptied, a notification will appear on the screen.

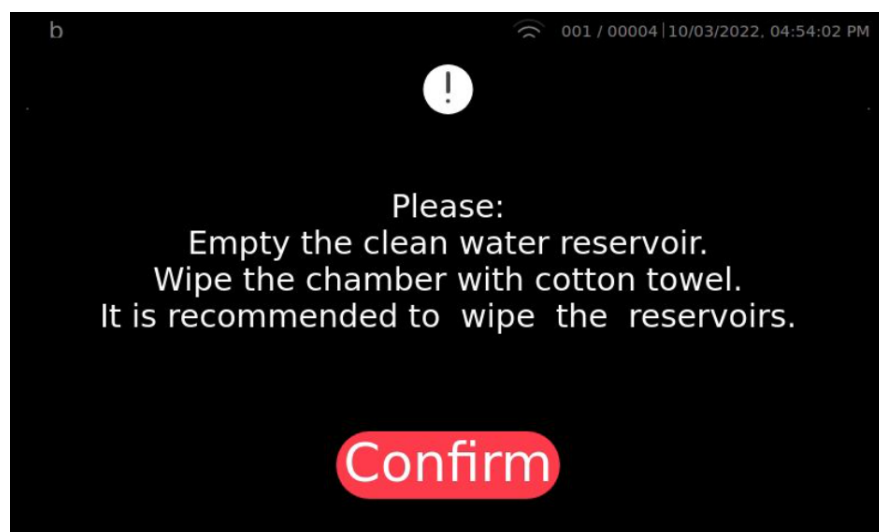

13. Press **Confirm**.
14. Fill the clean water reservoir with distilled water and run an Unwrapped Instrument cycle prior to returning the shelf holder and trays to the chamber.
15. Turn off the power and enable the chamber to cool completely.
16. Place the tray holder and trays back in the chamber.

Cat. No. MAN205-0504001EN Rev. C
COPYRIGHT ©